



POSEICO SPA
POwer SEMiconductors Italian COrporation

POSEICO SPA
Via N. Lorenzi 8, 16152 Genova - ITALY
Tel. ++ 39 010 6556234 - Fax ++ 39 010 6557519
Sales Office:
Tel. ++ 39 010 6556775 - Fax ++ 39 010 6442510

RECTIFIER DIODE

AR509LT

Repetitive voltage up to **600 V**
Mean forward current **5185 A**
Surge current **50 kA**

FINAL SPECIFICATION

Iug 02 - ISSUE : 03

Symbol	Characteristic	Conditions	T _j [°C]	Value	Unit
BLOCKING					
V _{RRM}	Repetitive peak reverse voltage		190	600	V
V _{RSM}	Non-repetitive peak reverse voltage		190	700	V
I _{RRM}	Repetitive peak reverse current	V=VRRM	190	75	mA
CONDUCTING					
I _{F(AV)}	Mean forward current	180° sin ,50 Hz, Th=55°C, double side cooled		5185	A
I _{F(AV)}	Mean forward current	180° sin ,50 Hz, Tc=85°C, double side cooled		5520	A
I _{FSM}	Surge forward current	Sine wave, 10 ms without reverse voltage	190	50	kA
I ² t	I ² t			12500 x 1E3	A ² s
V _{FM}	Forward voltage	Forward current = 4500 A	190	0.99	V
V _{F(TO)}	Threshold voltage		190	0.70	V
r _F	Forward slope resistance		190	0.065	mohm
SWITCHING					
t _{rr}	Reverse recovery time		190		μs
Q _{rr}	Reverse recovery charge				μC
I _{rr}	Peak reverse recovery current				A
MOUNTING					
R _{th(j-h)}	Thermal impedance, DC	Junction to heatsink, double side cooled		17	°C/kW
R _{th(c-h)}	Thermal impedance	Case to heatsink, double side cooled		5	°C/kW
T _j	Operating junction temperature			-30 / 190	°C
F	Mounting force			20.0 / 22.0	kN
	Mass			150	g

ORDERING INFORMATION : AR509LT S 06

standard specification VRRM/100

DISSIPATION CHARACTERISTICS

SQUARE WAVE

Th [°C]

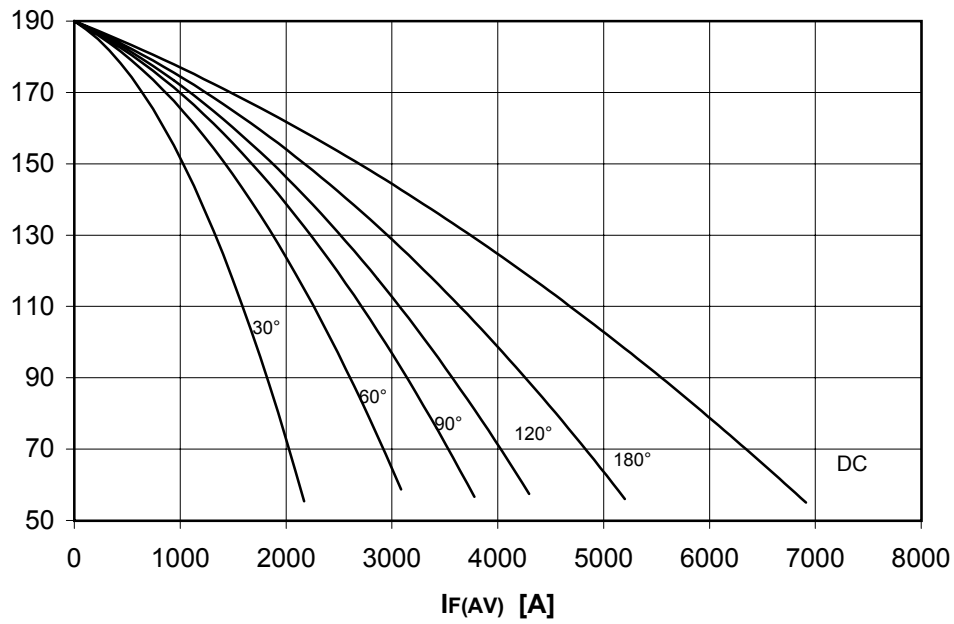

PF(AV) [W]

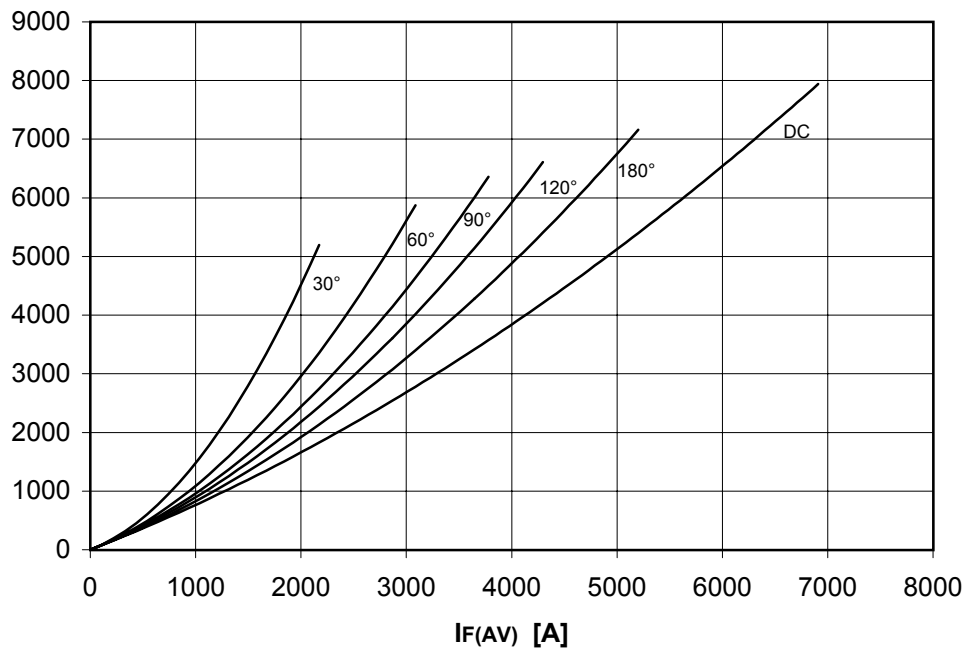

DISSIPATION CHARACTERISTICS

SINE WAVE

Th [°C]

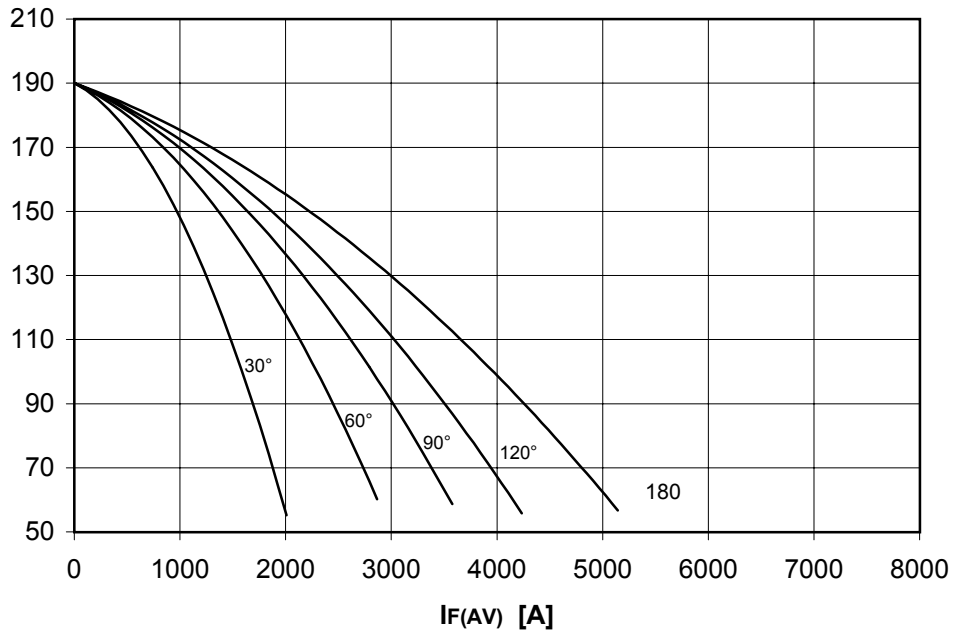

PF(AV) [W]

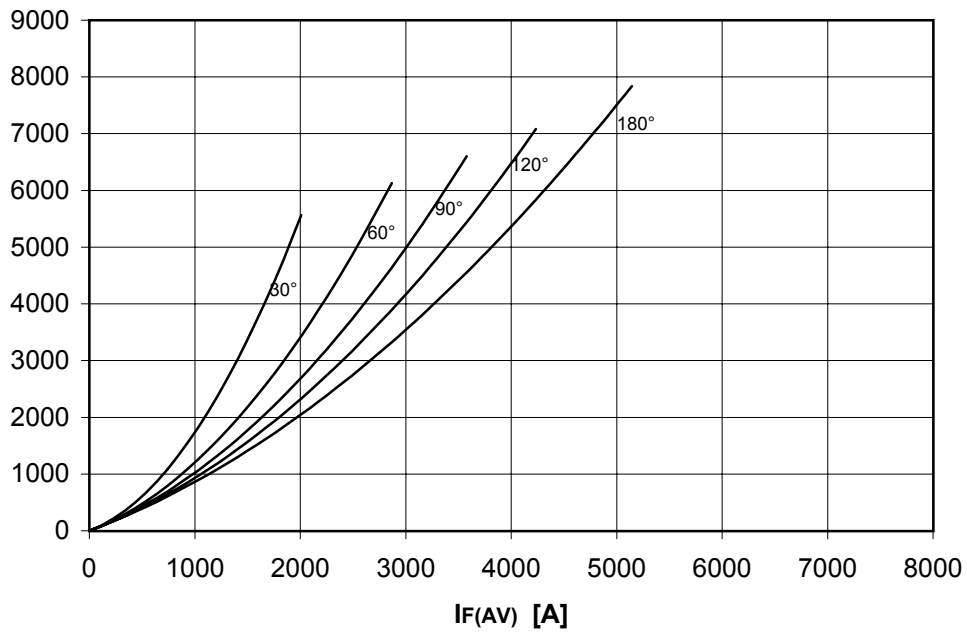

AR509LT RECTIFIER DIODE

FINAL SPECIFICATION lug 02 - ISSUE : 03

FORWARD CHARACTERISTIC
T_j = 190 °C

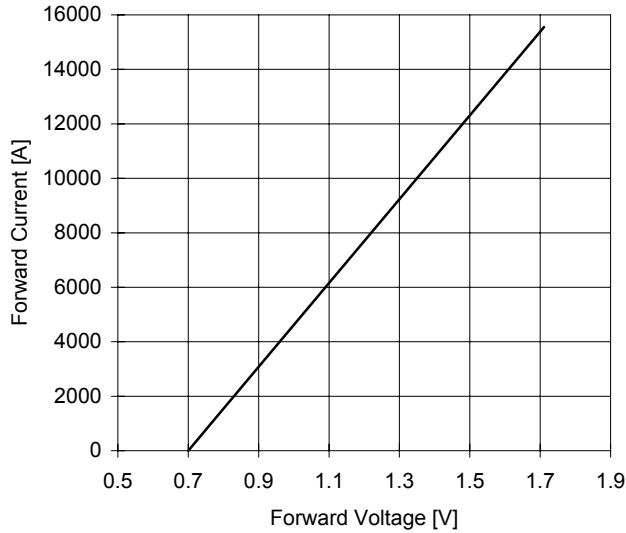

SURGE CHARACTERISTIC
T_j = 190 °C

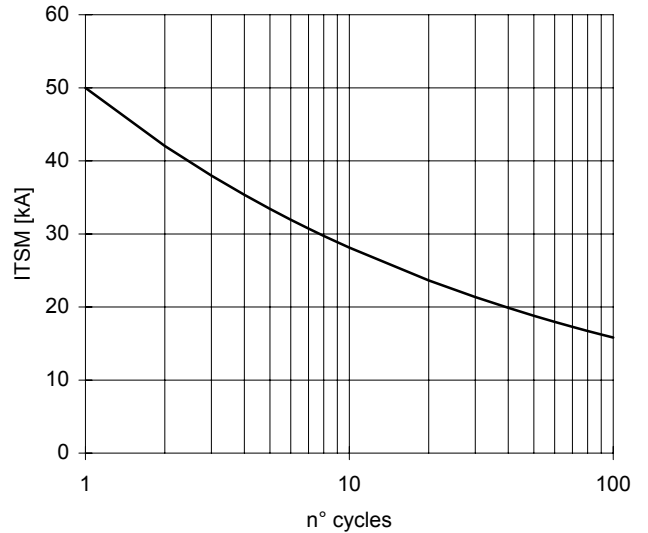

TRANSIENT THERMAL IMPEDANCE
DOUBLE SIDE COOLED

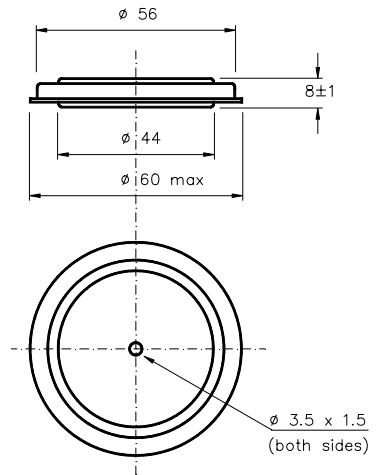
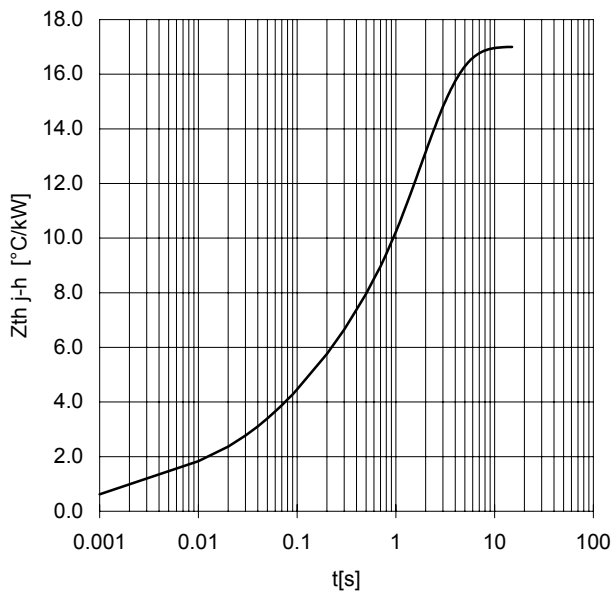

Dimensions
in mm

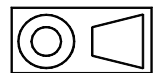

All the characteristics given in this data sheet are guaranteed only with uniform clamping force, cleaned and lubricated heatsink, surfaces with flatness < .03 mm and roughness < 2 μm.
In the interest of product improvement POSEICO SPA reserves the right to change any data given in this data sheet at any time without previous notice.
If not stated otherwise the maximum value of ratings (symbols over shaded background) and characteristics is reported.

Distributed by

