



P-Channel Enhancement Mode Field Effect Transistor

PRODUCT SUMMARY

V _{DSS}	I _D	R _{DS(ON)} (mΩ) TYP
-30V	-10A	40 @ V _{GS} = -10V
		67 @ V _{GS} = -4.5V

FEATURES

- Super high dense cell design for low R_{DS(ON)}.
- Rugged and reliable.
- TO-252 Package.

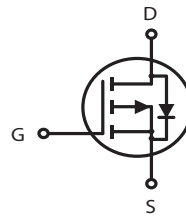

ABSOLUTE MAXIMUM RATINGS (T_C=25°C unless otherwise noted)

Parameter	Symbol	Limit	Unit
Drain-Source Voltage	V _{DS}	-30	V
Gate-Source Voltage	V _{GS}	±20	V
Drain Current-Continuous @ T _J =125°C -Pulsed ^a	I _D	-10	A
	I _{DM}	-30	A
Drain-Source Diode Forward Current	I _S	1.9	A
Maximum Power Dissipation @ T _C =25°C Derate above 25°C	P _D	2.5	W
Operating and Storage Temperature Range	T _J , T _{STG}	-55 to 150	°C

THERMAL CHARACTERISTICS

Thermal Resistance, Junction-to-Case	R _{θJC}	3	°C/W
Thermal Resistance, Junction-to-Ambient	R _{θJA}	50	°C/W

SDU9435A

ELECTRICAL CHARACTERISTICS (T_c = 25°C unless otherwise noted)

Parameter	Symbol	Condition	Min	Typ ^c	Max	Unit
OFF CHARACTERISTICS						
Drain-Source Breakdown Voltage	BV _{DSS}	V _{GS} = 0V, I _D = -250uA	-30			V
Zero Gate Voltage Drain Current	I _{DSS}	V _{DS} = -24V, V _{GS} = 0V			-1	uA
Gate-Body Leakage	I _{GSS}	V _{GS} = ±20V, V _{DS} = 0V			±100	nA
ON CHARACTERISTICS^b						
Gate Threshold Voltage	V _{GS(th)}	V _{DS} = V _{GS} , I _D = -250uA	-1	-1.5	-3	V
Drain-Source On-State Resistance	R _{DS(ON)}	V _{GS} = -10V, I _D = -5.3A		40	50	m-ohm
		V _{GS} = -4.5V, I _D = -4.2A		67	90	m-ohm
On-State Drain Current	I _{D(ON)}	V _{DS} = -5V, V _{GS} = -10V	-20			A
Forward Transconductance	g _{FS}	V _{DS} = -15V, I _D = -5.3A		9		S
DYNAMIC CHARACTERISTICS^c						
Input Capacitance	C _{ISS}	V _{DS} = -15V, V _{GS} = 0V f = 1.0MHz		860		pF
Output Capacitance	C _{OSS}			470		pF
Reverse Transfer Capacitance	C _{RSS}			180		pF
SWITCHING CHARACTERISTICS^c						
Turn-On Delay Time	t _{D(ON)}	V _D = -15V, I _D = -1A, V _{GEN} = -10V, R _{GEN} = 6 -ohm		9	20	ns
Rise Time	t _r			10	40	ns
Turn-Off Delay Time	t _{D(OFF)}			37	90	ns
Fall Time	t _f			23	110	ns
Total Gate Charge	Q _g	V _{DS} = -15V, I _D = -5.3A, V _{GS} = -10V		15	20	nC
		V _{DS} = -15V, I _D = -5.3A, V _{GS} = -4.5V		8.6	10.5	nC
Gate-Source Charge	Q _{gs}	V _{DS} = -15V, I _D = -5.3A, V _{GS} = -10V		3		nC
Gate-Drain Charge	Q _{gd}			4		nC

S DU9435A

ELECTRICAL CHARACTERISTICS ($T_c=25^\circ\text{C}$ unless otherwise noted)

Parameter	Symbol	Condition	Min	Typ ^c	Max	Unit
DRAIN-SOURCE DIODE CHARACTERISTICS^b						
Diode Forward Voltage	V_{SD}	$V_{GS} = 0V, I_s = -5.3A$		-0.84	-1.3	V

Notes

a. Pulse Test: Pulse Width $\leq 300\mu\text{s}$, Duty Cycle $\leq 2\%$.

b. Guaranteed by design, not subject to production testing.

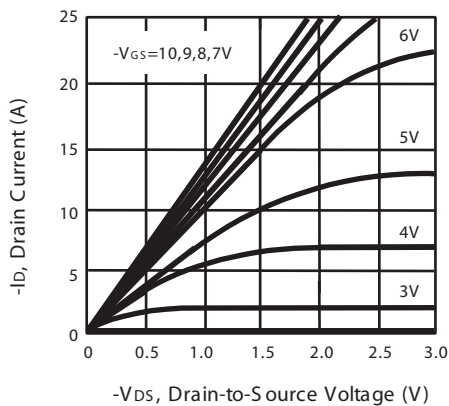

Figure 1. Output Characteristics

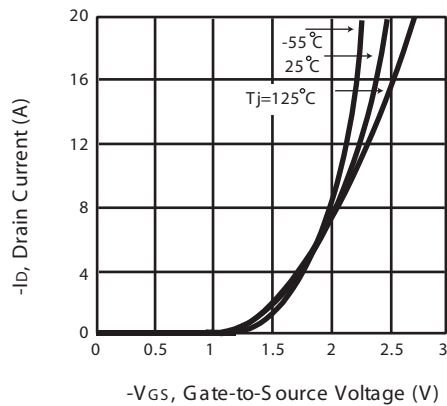

Figure 2. Transfer Characteristics

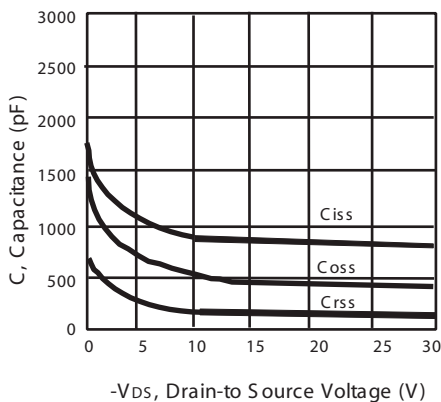

Figure 3. Capacitance

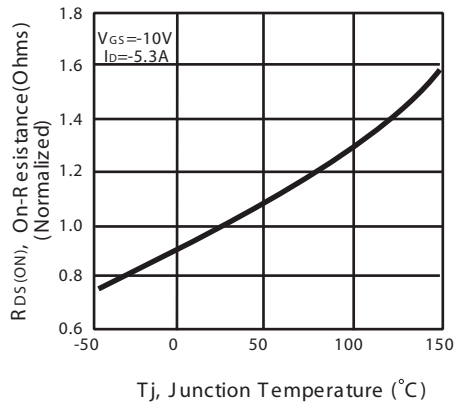

Figure 4. On-Resistance Variation with Temperature

SDU9435A

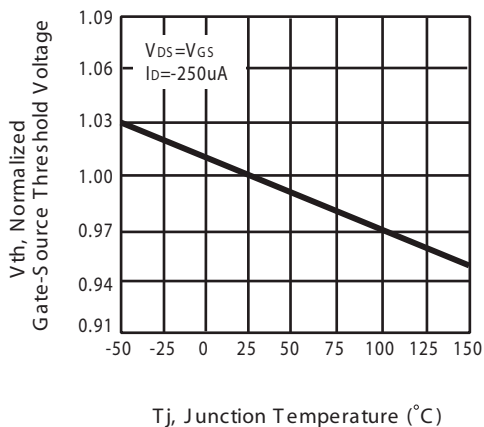

Figure 5. Gate Threshold Variation with Temperature

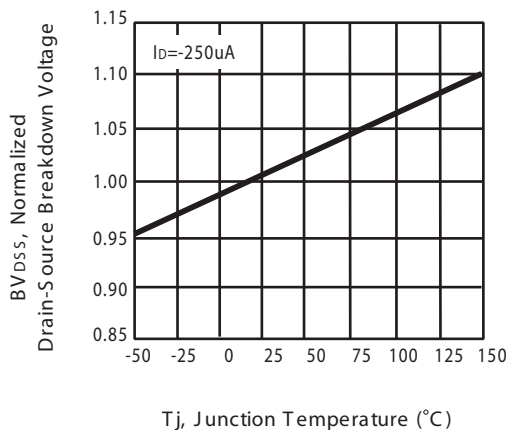

Figure 6. Breakdown Voltage Variation with Temperature

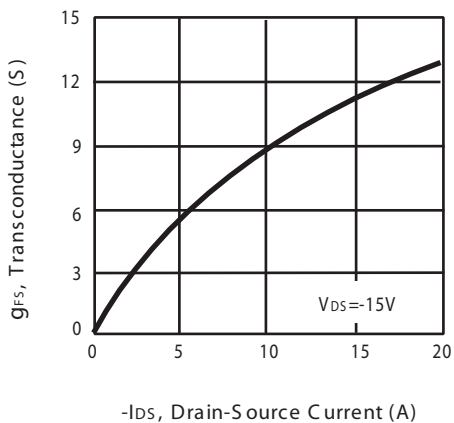

Figure 7. Transconductance Variation with Drain Current

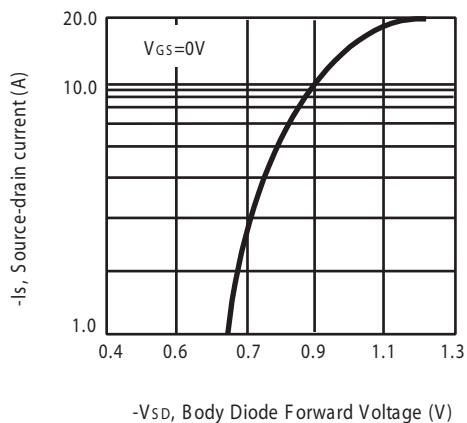

Figure 8. Body Diode Forward Voltage Variation with Source Current

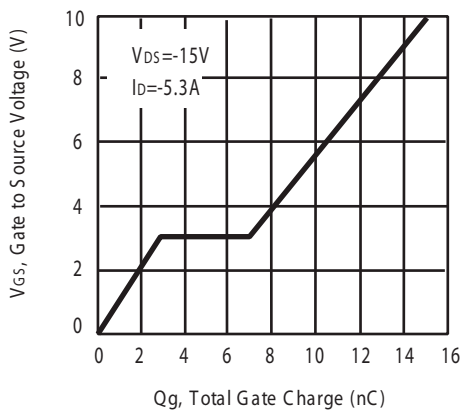

Figure 9. Gate Charge

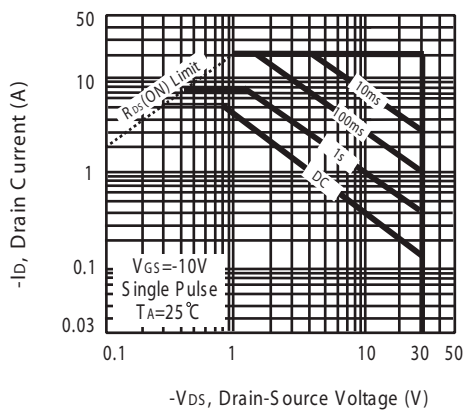

Figure 10. Maximum Safe Operating Area

SDU9435A

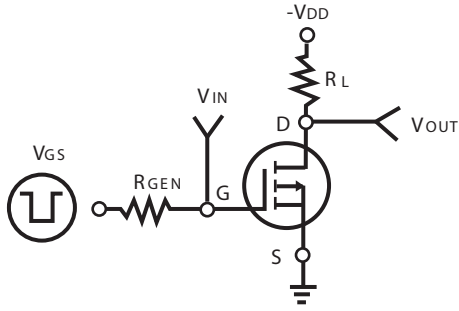

Figure 11. Switching Test Circuit

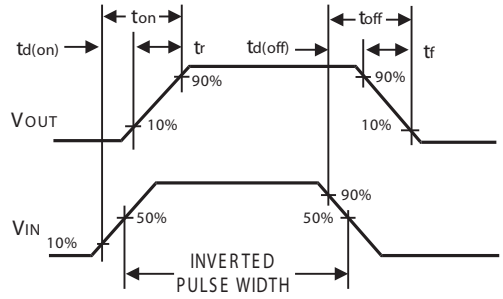

Figure 12. Switching Waveforms

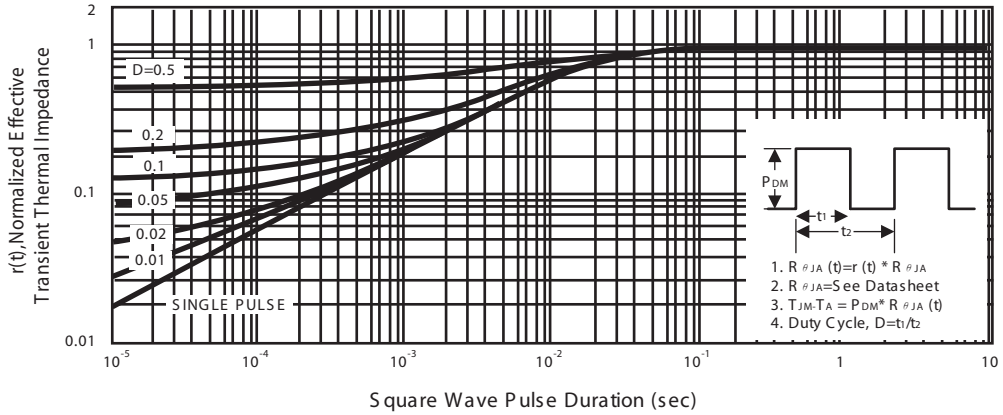

Figure 13. Normalized Thermal Transient Impedance Curve