

HIGH CURRENT SWITCHING APPLICATION.
INTERFACE CIRCUIT AND DRIVER CIRCUIT APPLICATION.

FEATURES

- With Built-in Bias Resistors.
- Simplify Circuit Design.
- Reduce a Quantity of Parts and Manufacturing Process.
- High Output Current :-800mA.

EQUIVALENT CIRCUIT

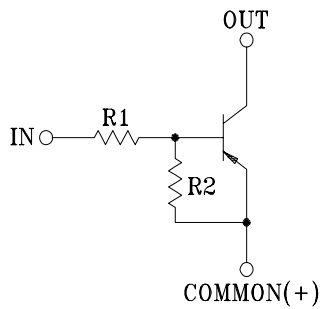

TYPE NO.	R1(kΩ)	R2(kΩ)
KRA221S	1	1
KRA222S	2.2	2.2
KRA223S	4.7	4.7
KRA224S	10	10
KRA225S	1	10
KRA226S	2.2	10

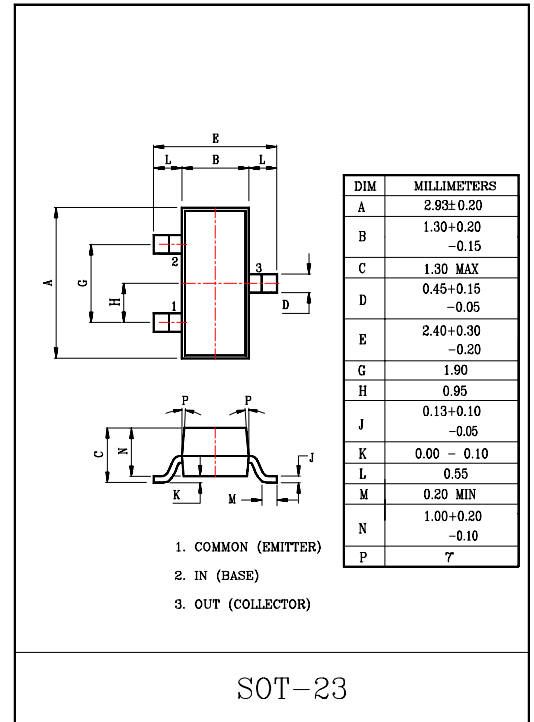

MAXIMUM RATINGS(Ta=25°C)

CHARACTERISTIC		SYMBOL	RATING	UNIT
Output Voltage	KRA221S ~ 226S	V _o	-50	V
Input Voltage	KRA221S	V _i	-10, 10	V
	KRA222S		-12, 10	
	KRA223S		-20, 10	
	KRA224S		-30, 10	
	KRA225S		-10, 5	
	KRA226S		-12, 6	
Output Current	KRA221S ~226S	I _o	-800	mA
Power Dissipation		P _D	200	mW
Junction Temperature		T _j	150	°C
Storage Temperature Range		T _{stg}	-55~150	°C

MARK SPEC

TYPE	KRA221S	KRA222S	KRA223S	KRA224S	KRA225S	KRA226S
MARK	PQ	PR	PS	PT	PU	PV

Marking

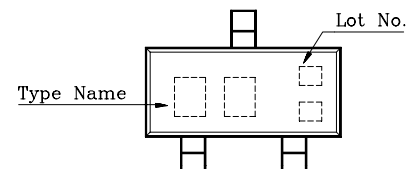

KRA221S ~ KRA226S

ELECTRICAL CHARACTERISTICS(Ta=25°C)

CHARACTERISTIC		SYMBOL	TEST CONDITION	MIN.	TYP.	MAX.	UNIT
Output Cut-off Current	KRA221S~226S	$I_{O(OFF)}$	$V_0=-30V, V_I=0$	-	-	-10	μA
DC Current Gain	KRA221S	G_I	$V_0=-5V, I_0=-50mA$	33	-	-	
	KRA222S			39	-	-	
	KRA223S			47	-	-	
	KRA224S			56	-	-	
	KRA225S			56	-	-	
	KRA226S			56	-	-	
Output Voltage	KRA221S~226S	$V_{O(ON)}$	$I_0=-50mA, I_f=-2.5mA$	-	-0.1	-0.3	V
Input Voltage (ON)	KRA221S	$V_{I(ON)}$	$V_0=-0.3V, I_0=-20mA$	-	-	-3.0	V
	KRA222S			-	-	-3.0	
	KRA223S			-	-	-3.0	
	KRA224S			-	-	-3.0	
	KRA225S			-	-	-3.0	
	KRA226S			-	-	-2.0	
Input Voltage (OFF)	KRA221S~224S	$V_{I(OFF)}$	$V_0=-5V, I_0=-0.1mA$	-0.5	-	-	V
	KRA225S~226S			-0.3	-	-	
Transition Frequency	KRA221S~226S	f_T^*	$V_0=-10V, I_0=-5mA, f=100MHz$	-	200	-	MHz
Input Current	KRA221S	I_I	$V_I=-5V$	-	-	-7.2	mA
	KRA222S			-	-	-3.8	
	KRA223S			-	-	-1.8	
	KRA224S			-	-	-0.88	
	KRA225S			-	-	-7.2	
	KRA226S			-	-	-3.6	

Note : *Characteristic of Transistor Only

KRA221S ~ KRA226S

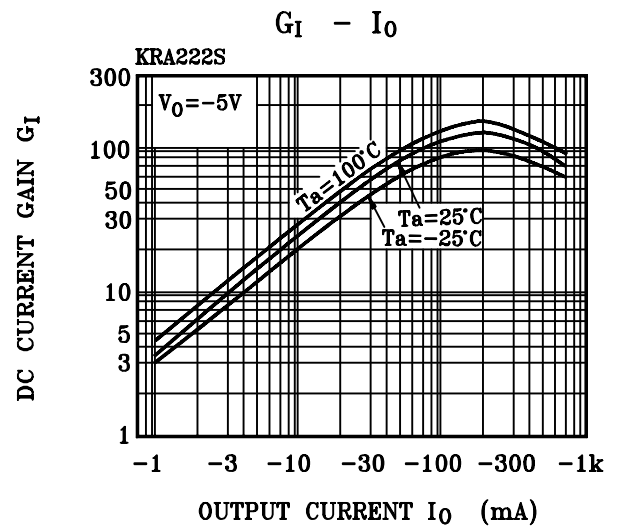
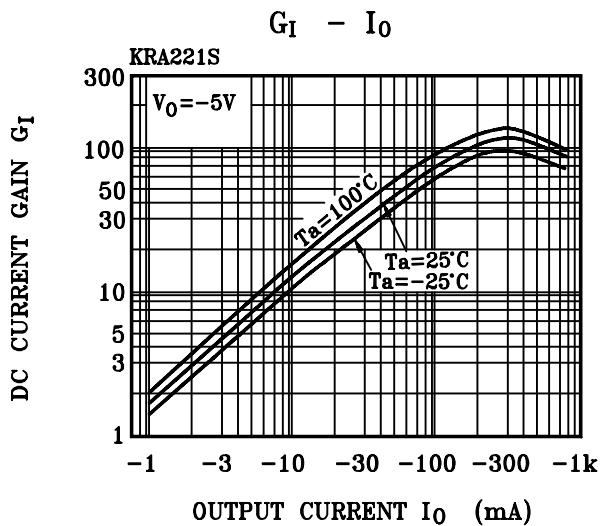
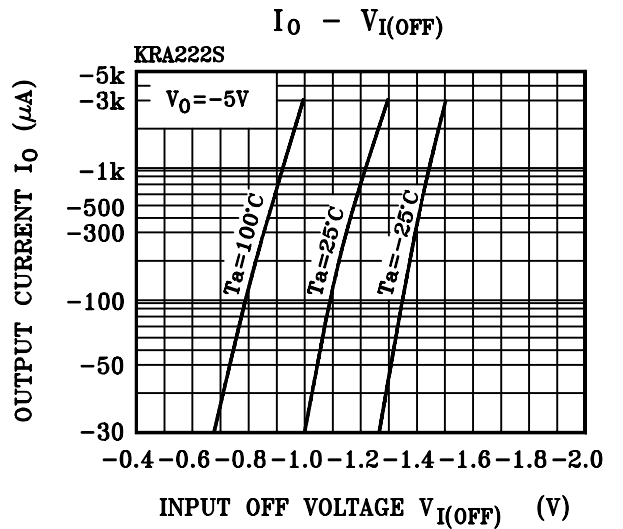
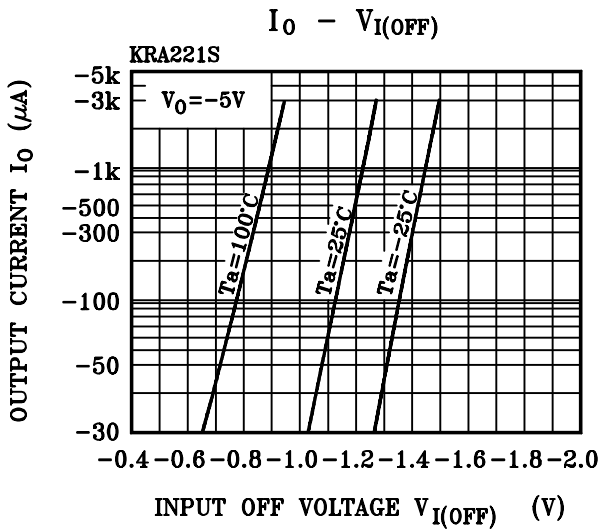
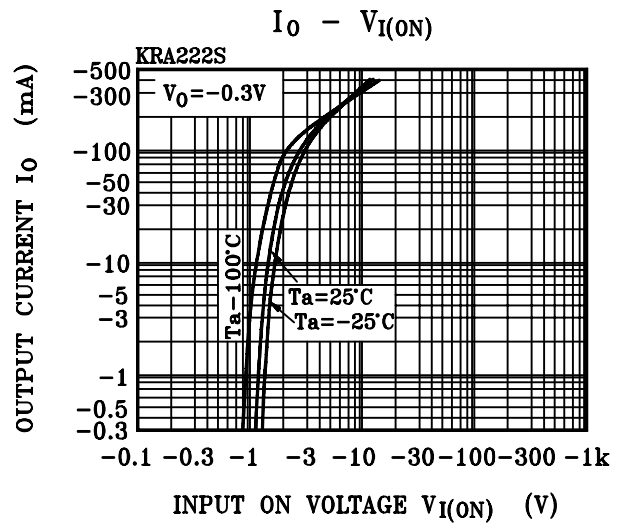
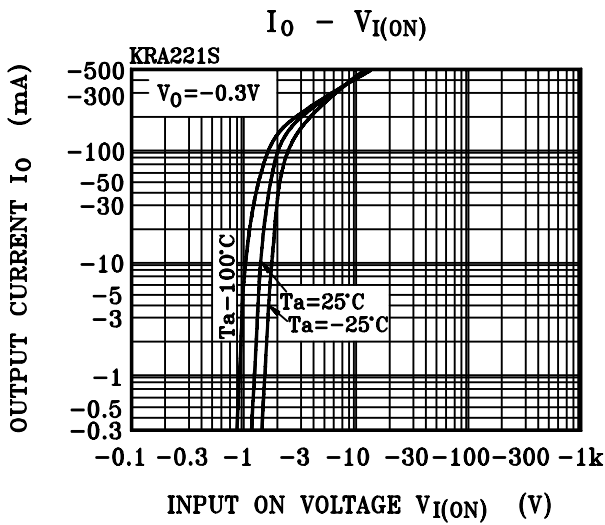

KRA221S ~ KRA226S

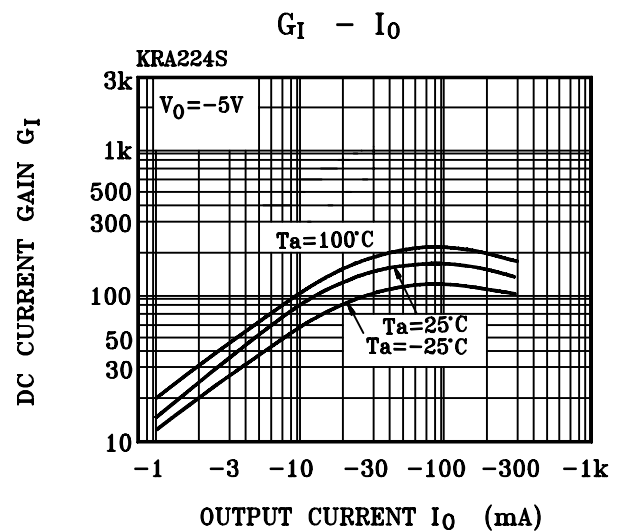
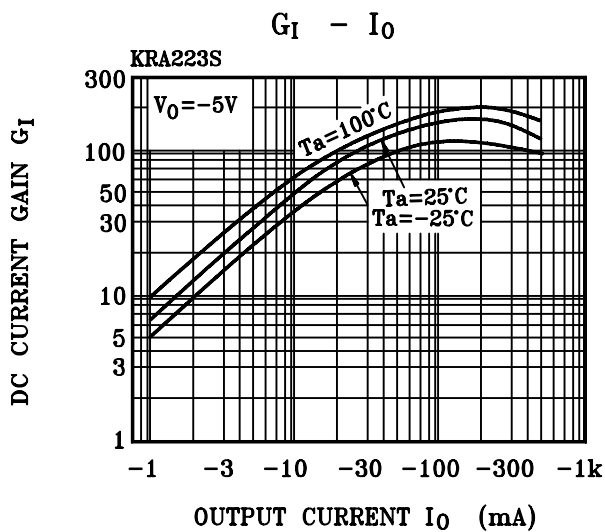
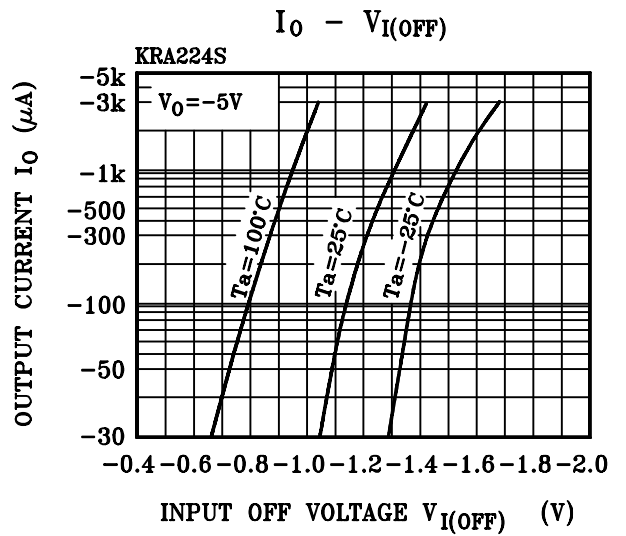
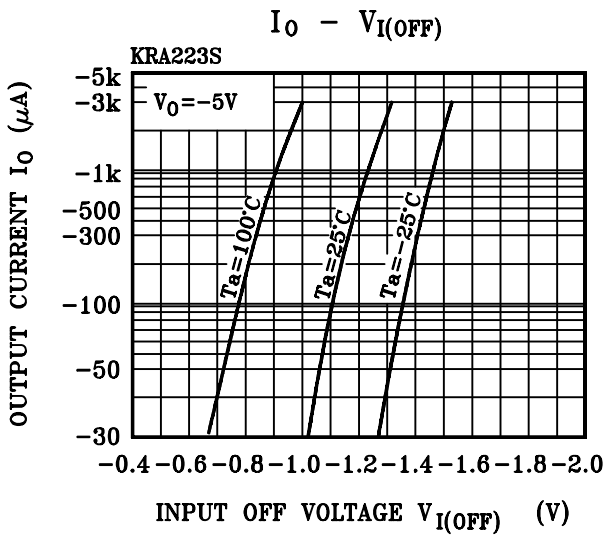
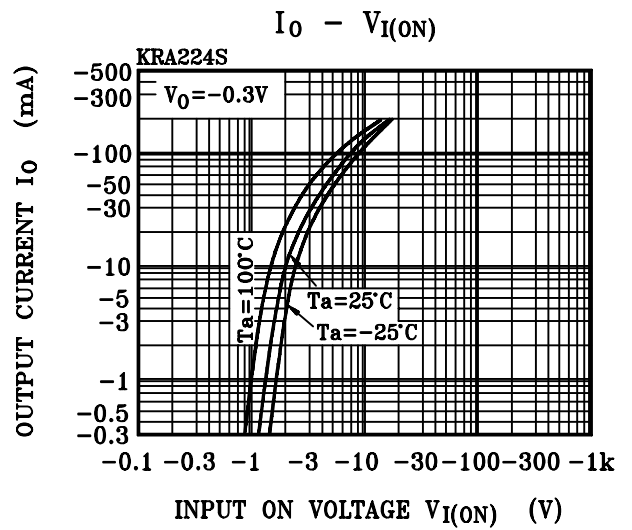
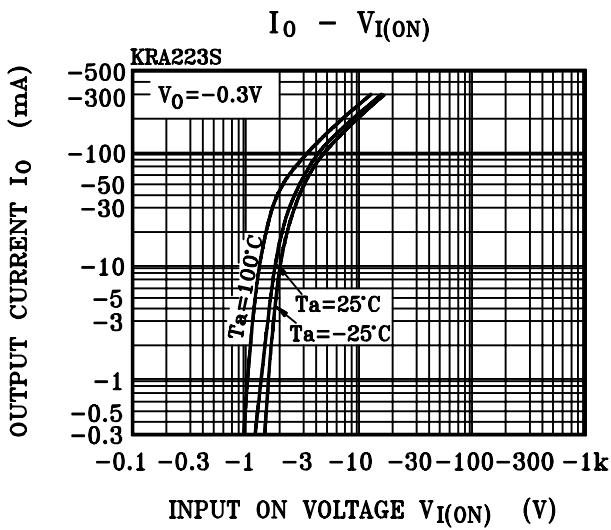

KRA221S ~ KRA226S

