

## 256MB – 32Mx72 DDR SDRAM UNBUFFERED w/PLL

### FEATURES

- Double-data-rate architecture
- DDR200, DDR266 and DDR300
  - JEDEC design specifications
- Bi-directional data strobes (DQS)
- Differential clock inputs (CK & CK#)
- Programmable Read Latency 2,2.5 (clock)
- Programmable Burst Length (2,4,8)
- Programmable Burst type (sequential & interleave)
- Edge aligned data output, center aligned data input
- Auto and self refresh
- Serial presence detect
- Power supply: 2.5V ± 0.2V
- JEDEC standard 200 pin SO-DIMM package
  - Package height options:  
AD4: 35.5 mm (1.38") and  
BD4: 31.75 mm (1.25")

### DESCRIPTION

The W3EG7232S is a 32Mx72 Double Data Rate SDRAM memory module based on 256Mb DDR SDRAM components. The module consists of nine 32Mx8 DDR SDRAMs in 66 pin TSOP packages mounted on a 200 pin FR4 substrate.

Synchronous design allows precise cycle control with the use of system clock. Data I/O transactions are possible on both edges and Burst Lengths allow the same device to be useful for a variety of high bandwidth, high performance memory system applications.

\* This product is subject to change without notice.

NOTE: Consult factory for availability of:

- RoHS compliant products
- Vendor source control options
- Industrial temperature option

### OPERATING FREQUENCIES

	DDR333 @CL=2.5	DDR266 @CL=2	DDR266 @CL=2.5	DDR200 @CL=2
Clock Speed	166MHz	133MHz	133MHz	100MHz
CL-trCD-trP	2.5-3-3	2-2-2	2.5-3-3	2-2-2

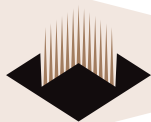

## PIN CONFIGURATION

Pin	Symbol	Pin	Symbol	Pin	Symbol	Pin	Symbol
1	VREF	51	Vss	101	A9	151	DQ42
2	VREF	52	Vss	102	AB	152	DQ46
3	Vss	53	DQ19	103	Vss	153	DQ43
4	Vss	54	DQ23	104	Vss	154	DQ47
5	DQ0	55	DQ24	105	A7	155	Vcc
6	DQ4	56	DQ28	106	A6	156	Vcc
7	DQ1	57	Vcc	107	A5	157	Vcc
8	DQ5	58	Vcc	108	A4	158	NC
9	Vcc	59	DQ25	109	A3	159	Vss
10	Vcc	60	DQ29	110	A2	160	NC
11	DQS0	61	DQS3	111	A1	161	Vss
12	DQM0	62	DQM3	112	A0	162	Vss
13	DQ2	63	Vss	113	Vcc	163	DQ48
14	DQ6	64	Vss	114	Vcc	164	DQ52
15	Vss	65	DQ26	115	A10/AP	165	DQ49
16	Vss	66	DQ30	116	BA1	166	DQ53
17	DQ3	67	DQ27	117	BA0	167	Vcc
18	DQ7	68	DQ31	118	RAS#	168	Vcc
19	DQ8	69	Vcc	119	WE#	169	DQS6
20	DQ12	70	Vcc	120	CAS#	170	DQM6
21	Vcc	71	CB0	121	CS0#	171	DQ50
22	Vcc	72	CB4	122	NC	172	DQ54
23	DQ9	73	CB1	123	NC	173	Vss
24	DQ13	74	CB5	124	NC	174	Vss
25	DQS1	75	Vss	125	Vss	175	DQ51
26	DQM1	76	Vss	126	Vss	176	DQ55
27	Vss	77	DQS8	127	DQ32	177	DQ56
28	Vss	78	DQM8	128	DQ36	178	DQ60
29	DQ10	79	CB2	129	DQ33	179	Vcc
30	DQ14	80	CB6	130	DQ37	180	Vcc
31	DQ11	81	Vcc	131	Vcc	181	DQ57
32	DQ15	82	Vcc	132	Vcc	182	DQ61
33	Vcc	83	CB3	133	DQS4	183	DQS7
34	Vcc	84	CB7	134	DQM4	184	DQM7
35	CK0	85	NC	135	DQ34	185	Vss
36	Vcc	86	NC	136	DQ38	186	Vss
37	CK0#	87	Vss	137	Vss	187	DQ58
38	Vss	88	Vss	138	Vss	188	DQ62
39	Vss	89	NC	139	DQ35	189	DQ59
40	Vss	90	Vss	140	DQ39	190	DQ63
41	DQ16	91	NC	141	DQ40	191	Vcc
42	DQ20	92	Vcc	142	DQ44	192	Vcc
43	DQ17	93	Vcc	143	Vcc	193	SDA
44	DQ21	94	Vcc	144	Vcc	194	SA0
45	Vcc	95	NC	145	DQ41	195	SCL
46	Vcc	96	CKE0	146	DQ45	196	SA1
47	DQS2	97	NC	147	DQS5	197	VCCSPD
48	DQM2	98	NC	148	DQM5	198	SA2
49	DQ18	99	A12	149	Vss	199	VCCID
50	DQ22	100	A11	150	Vss	200	NC

## PIN NAMES

A0 – A12	Address input (Multiplexed)
BA0-BA1	Bank Select Address
DQ0-DQ63	Data Input/Output
CB0-CB7	Check bits
DQS0-DQS8	Data Strobe Input/Output
CK0	Clock Input
CK0#	Clock Input
CKE0	Clock Enable Input
CS0#	Chip Select Input
RAS#	Row Address Strobe
CAS#	Column Address Strobe
WE#	Write Enable
DQM0-DQM8	Data-In Mask
Vcc	Power Supply
VCCQ	Power Supply for DQS
Vss	Ground
VREF	Power Supply for Reference
VCCSPD	Serial EEPROM Power Supply
SDA	Serial Data I/O
SCL	Serial Clock
SA0-SA2	Address in EEPROM
VCCID	Vcc Identification Flag
NC	No Connect

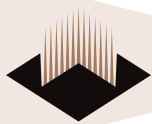

### FUNCTIONAL BLOCK DIAGRAM

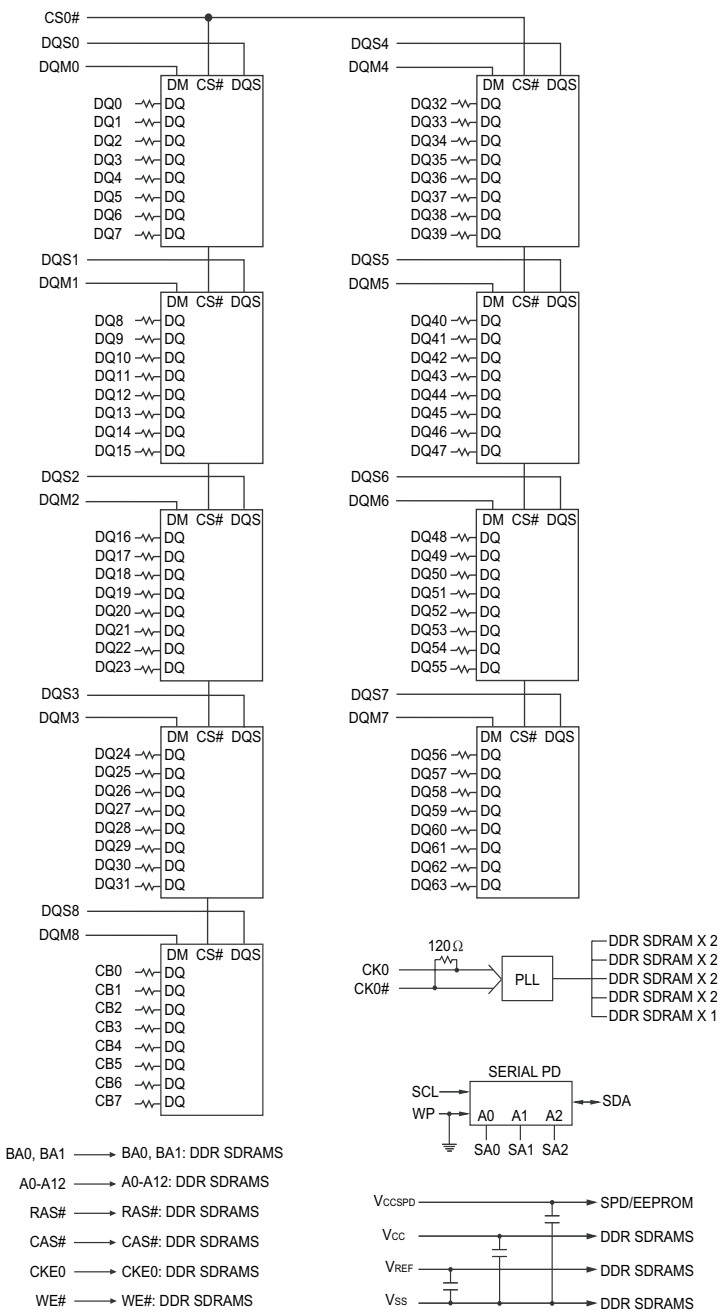

Note: All resistor values are 22Ω unless otherwise indicated.

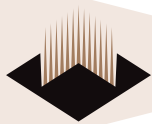

**ABSOLUTE MAXIMUM RATINGS**

Parameter	Symbol	Value	Units
Voltage on any pin relative to V <sub>SS</sub>	V <sub>IN</sub> , V <sub>OUT</sub>	- 0.5 ~ 3.6	V
Voltage on V <sub>CC</sub> supply relative to V <sub>SS</sub>	V <sub>CC</sub> , V <sub>CCQ</sub>	-1.0 ~ 3.6	V
Storage Temperature	T <sub>STG</sub>	- 55 ~ +150	°C
Power Dissipation	P <sub>D</sub>	9	W
Short Circuit Current	I <sub>OS</sub>	50	mA

Note:  
Permanent device damage may occur if "ABSOLUTE MAXIMUM RATINGS" are exceeded.  
Functional operation should be restricted to recommended operating condition.  
Exposure to higher than recommended voltage for extended periods of time could affect device reliability.

**DC CHARACTERISTICS**

0°C ≤ T<sub>A</sub> ≤ 70°C, V<sub>CC</sub> = 2.5V ± 0.2V

Parameter	Symbol	Min	Max	Unit
Supply Voltage	V <sub>CC</sub>	2.3	2.7	V
Supply Voltage	V <sub>CCQ</sub>	2.3	2.7	V
Reference Voltage	V <sub>REF</sub>	1.15	1.35	V
Termination Voltage	V <sub>TT</sub>	1.15	1.35	V
Input High Voltage	V <sub>IH</sub>	V <sub>REF</sub> + 0.15	V <sub>CCQ</sub> + 0.3	V
Input Low Voltage	V <sub>IL</sub>	- 0.3	V <sub>REF</sub> - 0.15	V
Output High Voltage	V <sub>OH</sub>	V <sub>TT</sub> + 0.76	—	V
Output Low Voltage	V <sub>OL</sub>	—	V <sub>TT</sub> - 0.76	V

**CAPACITANCE**

T<sub>A</sub> = 25°C, f = 1MHz, V<sub>CC</sub> = 2.5V ± 0.2V

Parameter	Symbol	Max	Unit
Input Capacitance (A0-A12)	C <sub>IN1</sub>	29	pF
Input Capacitance (RAS#,CAS#,WE#)	C <sub>IN2</sub>	29	pF
Input Capacitance (CKE0,CKE1)	C <sub>IN3</sub>	29	pF
Input Capacitance (CK0,CK0#)	C <sub>IN4</sub>	5.5	pF
Input Capacitance (CS0#,CS1#)	C <sub>IN5</sub>	29	pF
Input Capacitance (DQM0-DQM8)	C <sub>IN6</sub>	8	pF
Input Capacitance (BA0-BA1)	C <sub>IN7</sub>	29	pF
Data input/output Capacitance (DQ0-DQ63)(DQS)	C <sub>OUT</sub>	8	pF
Data input/output Capacitance (CB0-CB7)	C <sub>OUT</sub>	8	pF

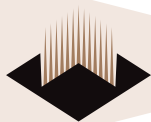

**I<sub>DD</sub> SPECIFICATIONS AND TEST CONDITIONS**

0°C □ TA □ 70°C, V<sub>CCQ</sub> = 2.5V ± 0.2V, V<sub>CC</sub> = 2.5V ± 0.2V

Parameter	Symbol	Conditions	DDR333@ CL=2.5	DDR266@ CL=2, 2.5	DDR200@ CL=2	Units
			Max	Max	Max	
Operating Current	I <sub>DD0</sub>	One device bank; Active - Precharge; (MIN); DQ,DM and DQS inputs changing once per clock cycle; Address and control inputs changing once every two cycles. T <sub>RC</sub> =T <sub>RC</sub> (MIN); T <sub>CK</sub> =T <sub>CK</sub>	1400	1400	1400	mA
Operating Current	I <sub>DD1</sub>	One device bank; Active-Read-Precharge; Burst = 2; T <sub>RC</sub> =T <sub>RC</sub> (MIN); T <sub>CK</sub> =T <sub>CK</sub> (MIN); I <sub>OUT</sub> = 0mA; Address and control inputs changing once per clock cycle.	1805	1805	1715	mA
Precharge Power-Down Standby Current	I <sub>DD2P</sub>	All device banks idle; Power-down mode; T <sub>CK</sub> =T <sub>CK</sub> (MIN); CKE=(low)	36	36	36	mA
Idle Standby Current	I <sub>DD2F</sub>	CS# = High; All device banks idle; T <sub>CK</sub> =T <sub>CK</sub> (MIN); CKE = high; Address and other control inputs changing once per clock cycle. V <sub>IN</sub> = V <sub>REF</sub> for DQ, DQS and DM.	725	725	680	mA
Active Power-Down Standby Current	I <sub>DD3P</sub>	One device bank active; Power-down mode; T <sub>CK</sub> (MIN); CKE=(low)	270	270	225	mA
Active Standby Current	I <sub>DD3N</sub>	CS# = High; CKE = High; One device bank; Active-Precharge; T <sub>RC</sub> =T <sub>RAS</sub> (MAX); T <sub>CK</sub> =T <sub>CK</sub> (MIN); DQ, DM and DQS inputs changing twice per clock cycle; Address and other control inputs changing once per clock cycle.	815	815	725	mA
Operating Current	I <sub>DD4R</sub>	Burst = 2; Reads; Continous burst; One device bank active; Address and control inputs changing once per clock cycle; T <sub>CK</sub> =T <sub>CK</sub> (MIN); I <sub>OUT</sub> = 0mA.	1850	1850	1625	mA
Operating Current	I <sub>DD4W</sub>	Burst = 2; Writes; Continous burst; One device bank active; Address and control inputs changing once per clock cycle; T <sub>CK</sub> =T <sub>CK</sub> (MIN); DQ,DM and DQS inputs changing twice per clock cycle.	1850	1850	1625	mA
Auto Refresh Current	I <sub>DD5</sub>	T <sub>RC</sub> =T <sub>RC</sub> (MIN)	2570	2570	2390	mA
Self Refresh Current	I <sub>DD6</sub>	CKE ≤ 0.2V	311	311	311	mA
Operating Current	I <sub>DD7A</sub>	Four bank interleaving Reads (BL=4) with auto precharge with T <sub>RC</sub> =T <sub>RC</sub> (MIN); T <sub>CK</sub> =T <sub>CK</sub> (MIN); Address and control inputs change only during Active Read or Write commands	3965	3965	3425	mA

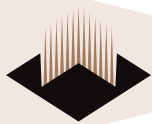

**DETAILED TEST CONDITIONS FOR DDR SDRAM I<sub>DD1</sub> & I<sub>DD7A</sub>**

**I<sub>DD1</sub> : OPERATING CURRENT : ONE BANK**

1. Typical Case : V<sub>CC</sub>=2.5V, T=25°C
2. Worst Case : V<sub>CC</sub>=2.7V, T=10°C
3. Only one bank is accessed with t<sub>RC</sub> (min), Burst Mode, Address and Control inputs on NOP edge are changing once per clock cycle. I<sub>OUT</sub> = 0mA
4. Timing Patterns :
  - DDR200 (100 MHz, CL=2) : t<sub>CK</sub>=10ns, CL2, BL=4, t<sub>RCD</sub>=2\*t<sub>CK</sub>, t<sub>TRAS</sub>=5\*t<sub>CK</sub>  
Read : A0 N R0 N N P0 N A0 N - repeat the same timing with random address changing; 50% of data changing at every burst
  - DDR266 (133MHz, CL=2.5) : t<sub>CK</sub>=7.5ns, CL=2.5, BL=4, t<sub>RCD</sub>=3\*t<sub>CK</sub>, t<sub>RC</sub>=9\*t<sub>CK</sub>, t<sub>TRAS</sub>=5\*t<sub>CK</sub>  
Read : A0 N N R0 N P0 N N A0 N - repeat the same timing with random address changing; 50% of data changing at every burst
  - DDR266 (133MHz, CL=2) : t<sub>CK</sub>=7.5ns, CL=2, BL=4, t<sub>RCD</sub>=3\*t<sub>CK</sub>, t<sub>RC</sub>=9\*t<sub>CK</sub>, t<sub>TRAS</sub>=5\*t<sub>CK</sub>  
Read : A0 N N R0 N P0 N N A0 N - repeat the same timing with random address changing; 50% of data changing at every burst
  - DDR333 (166MHz, CL=2.5) : t<sub>CK</sub>=6ns, BL=4, t<sub>RCD</sub>=10\*t<sub>CK</sub>, t<sub>TRAS</sub>=7\*t<sub>CK</sub>  
Read : A0 N N R0 N P0 N N A0 N - repeat the same timing with random address changing; 50% of data changing at every burst

**I<sub>DD7A</sub> : OPERATING CURRENT : FOUR BANKS**

1. Typical Case : V<sub>CC</sub>=2.5V, T=25°C
2. Worst Case : V<sub>CC</sub>=2.7V, T=10°C
3. Four banks are being interleaved with t<sub>RC</sub> (min), Burst Mode, Address and Control inputs on NOP edge are not changing. I<sub>OUT</sub>=0mA
4. Timing Patterns :
  - DDR200 (100 MHz, CL=2) : t<sub>CK</sub>=10ns, CL2, BL=4, t<sub>RRD</sub>=2\*t<sub>CK</sub>, t<sub>RCD</sub>=3\*t<sub>CK</sub>, Read with Autoprecharge  
Read : A0 N A1 R0 A2 R1 A3 R2 A0 R3 A1 R0 - repeat the same timing with random address changing; 100% of data changing at every burst
  - DDR266 (133MHz, CL=2.5) : t<sub>CK</sub>=7.5ns, CL=2.5, BL=4, t<sub>RRD</sub>=3\*t<sub>CK</sub>, t<sub>RCD</sub>=3\*t<sub>CK</sub>  
Read with Autoprecharge  
Read : A0 N A1 R0 A2 R1 A3 R2 N R3 A0 N A1 R0 - repeat the same timing with random address changing; 100% of data changing at every burst
  - DDR266 (133MHz, CL=2) : t<sub>CK</sub>=7.5ns, CL2=2, BL=4, t<sub>RRD</sub>=2\*t<sub>CK</sub>, t<sub>RCD</sub>=2\*t<sub>CK</sub>  
Read : A0 N A1 R0 A2 R1 A3 R2 N R3 A0 N A1 R0 - repeat the same timing with random address changing; 100% of data changing at every burst
  - DDR333 (166MHz, CL=2.5) : t<sub>CK</sub>=6ns, BL=4, t<sub>RRD</sub>=3\*t<sub>CK</sub>, t<sub>RCD</sub>=3\*t<sub>CK</sub>, Read with Autoprecharge  
Read : A0 N A1 R0 A2 R1 A3 R2 N R3 A0 N A1 R0 - repeat the same timing with random address changing; 100% of data changing at every burst

Legend : A = Activate, R = Read, W = Write, P = Precharge, N = NOP

A (0-3) = Activate Bank 0-3

R (0-3) = Read Bank 0-3

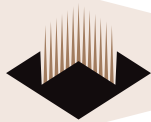

**ELECTRICAL CHARACTERISTICS AND RECOMMENDED AC OPERATING CONDITIONS**

AC CHARACTERISTICS			335		262		265		202			
PARAMETER		SYMBOL	MIN	MAX	MIN	MAX	MIN	MAX	MIN	MAX	UNITS	NOTES
Access window of DQs from CK/CK#		t <sub>AC</sub>	-0.7	+0.7	-0.75	+0.75	-0.75	+0.75	-0.75	+0.75	ns	
CK high-level width		t <sub>CH</sub>	0.45	0.55	0.45	0.55	0.45	0.55	0.45	0.55	t <sub>CK</sub>	26
CK low-level width		t <sub>CL</sub>	0.45	0.55	0.45	0.55	0.45	0.55	0.45	0.55	t <sub>CK</sub>	26
Clock cycle time	CL = 2.5	t <sub>CK (2.5)</sub>	6	13	7.5	13	7.5	13	7.5	13	ns	39, 44
	CL = 2	t <sub>CK (2)</sub>	7.5	13	7.5	13	7.5	13	10	13	ns	39, 44
DQ and DM input hold time relative to DQS		t <sub>DH</sub>	0.45		0.5		0.5		0.5		ns	23, 27
DQ and DM input setup time relative to DQS		t <sub>DS</sub>	0.45		0.5		0.5		0.5		ns	23, 27
DQ and DM input pulse width (for each input)		t <sub>DIPW</sub>	1.75		1.75		1.75		1.75		ns	27
Access window of DQS from CK/CK#		t <sub>DQSK</sub>	-0.6	+0.6	-0.75	+0.75	-0.75	+0.75	-0.75	+0.75	ns	
DQS input high pulse width		t <sub>DQSH</sub>	0.35		0.35		0.35		0.35		t <sub>CK</sub>	
DQS input low pulse width		t <sub>DQSL</sub>	0.35		0.35		0.35		0.35		t <sub>CK</sub>	
DQS-DQ skew, DQS to last DQ valid, per group, per access		t <sub>DQSQ</sub>		0.45		0.5		0.5		0.6	ns	22, 23
Write command to first DQS latching transition		t <sub>DQSS</sub>	0.75	1.25	0.75	1.25	0.75	1.25	0.75	1.25	t <sub>CK</sub>	
DQS falling edge to CK rising - setup time		t <sub>DSS</sub>	0.2		0.2		0.2		0.2		t <sub>CK</sub>	
DQS falling edge from CK rising - hold time		t <sub>DSH</sub>	0.2		0.2		0.2		0.2		t <sub>CK</sub>	
Half clock period		t <sub>HP</sub>			t <sub>CH, tCL</sub>				t <sub>CH, tCL</sub>		ns	30
Data-out high-impedance window from CK/CK#		t <sub>HZ</sub>		+0.7		+0.75		+0.75		+0.75	ns	16, 36
Data-out low-impedance window from CK/CK#		t <sub>LZ</sub>	-0.7		-0.75		-0.75		-0.75		ns	16, 36
Address and control input hold time (slow slew rate)		t <sub>IHS</sub>	0.80		0.90		1		1.1		ns	12
Address and control input setup time (slow slew rate)		t <sub>ISS</sub>	0.80		0.90		1		1.1		ns	12
Address and Control input pulse width (for each input)		t <sub>IPW</sub>	2.2		2.2		2.2		2.2		ns	
LOAD MODE REGISTER command cycle time		t <sub>MRD</sub>	12		15		15		15		ns	

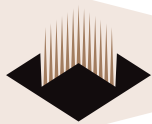

**ELECTRICAL CHARACTERISTICS AND RECOMMENDED AC OPERATING CONDITIONS (Continued)**

AC CHARACTERISTICS		335		262		265		202			
PARAMETER	SYMBOL	MIN	MAX	MIN	MAX	MIN	MAX	MIN	MAX	UNITS	NOTES
DQ-DQS hold, DQS to first DQ to go nonvalid, per access	t <sub>QH</sub>	t <sub>HP</sub> - t <sub>QHS</sub>		t <sub>HP</sub> - t <sub>QHS</sub>		t <sub>HP</sub> - t <sub>QHS</sub>		t <sub>HP</sub> - t <sub>QHS</sub>		ns	22, 23
Data Hold Skew Factor	t <sub>QHS</sub>		0.5		0.75		0.75		0.75	ns	
ACTIVE to PRECHARGE command	t <sub>RAS</sub>	42	70,000	40	120,000	40	120,000	40	120,000	ns	31, 47
ACTIVE to READ with Auto precharge command	t <sub>RAP</sub>	15		15		15		20		ns	
ACTIVE to ACTIVE/AUTO REFRESH command period	t <sub>RC</sub>	60		60		60		65		ns	
AUTO REFRESH command period	t <sub>RFC</sub>	72		75		75		75		ns	
ACTIVE to READ or WRITE delay	t <sub>RCD</sub>	15		15		15		20		ns	
PRECHARGE command period	t <sub>RP</sub>	15		15		15		20		ns	
DQS read preamble	t <sub>RPRE</sub>	0.9	1.1	0.9	1.1	0.9	1.1	0.9	1.1	t <sub>CK</sub>	37
DQS read postamble	t <sub>RPST</sub>	0.4	0.6	0.4	0.6	0.4	0.6	0.4	0.6	t <sub>CK</sub>	37
ACTIVE bank a to ACTIVE bank b command	t <sub>RRD</sub>	12		15		15		15		ns	
DQS write preamble	t <sub>WPRE</sub>	0.25		0.25		0.25		0.25		t <sub>CK</sub>	
DQS write preamble setup time	t <sub>WPRES</sub>	0		0		0		0		ns	18, 19
DQS write postamble	t <sub>WPST</sub>	0.4	0.6	0.4	0.6	0.4	0.6	0.4	0.6	t <sub>CK</sub>	17
Write recovery time	t <sub>WR</sub>	15		15		15		15		ns	
Internal WRITE to READ command delay	t <sub>WTR</sub>	1		1		1		1		t <sub>CK</sub>	
Data valid output window (DVW)	na			t <sub>QH</sub> - t <sub>DQSQ</sub>				t <sub>QH</sub> - t <sub>DQSQ</sub>		ns	22
REFRESH to REFRESH command interval	t <sub>REFC</sub>		70.3		70.3		70.3		70.3	μs	21
Average periodic refresh interval	t <sub>REFI</sub>		7.8		7.8		7.8	0	7.8	μs	
Terminating voltage delay to V <sub>CC</sub>	t <sub>VTD</sub>	0		0		0			0	ns	
Exit SELF REFRESH to non-READ command	t <sub>XSNR</sub>	75		75			75	75		ns	
Exit SELF REFRESH to READ command	t <sub>XSRD</sub>	200		200			200	200		t <sub>CK</sub>	



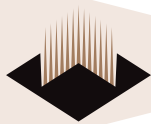

## Notes

1. All voltages referenced to V<sub>SS</sub>.
2. Tests for AC timing, I<sub>DD</sub>, and electrical AC and DC characteristics may be conducted at nominal reference/supply voltage levels, but the related specifications and device operation are guaranteed for the full voltage range specified.
3. Outputs measured with equivalent load:

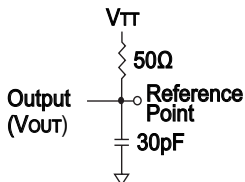

4. AC timing and I<sub>DD</sub> tests may use a V<sub>IL</sub>-to-V<sub>IH</sub> swing of up to 1.5V in the test environment, but input timing is still referenced to V<sub>REF</sub> (or to the crossing point for CK/CK#), and parameter specifications are guaranteed for the specified AC input levels under normal use conditions. The mini-mum slew rate for the input signals used to test the device is 1V/ns in the range between V<sub>IL</sub>(AC) and V<sub>IH</sub>(AC).
5. The AC and DC input level specifications are as defined in the SSTL\_2 Standard (i.e., the receiver will effectively switch as a result of the signal crossing the AC input level, and will remain in that state as long as the signal does not ring back above [below] the DC input LOW [HIGH] level).
6. V<sub>REF</sub> is expected to equal V<sub>CCQ2</sub> of the transmitting device and to track variations in the DC level of the same. Peak-to-peak noise (non-common mode) on V<sub>ref</sub> may not exceed ±2 percent of the DC value. Thus, from V<sub>CCQ2</sub>, V<sub>ref</sub> is allowed ±25mV for DC error and an additional ±25mV for AC noise. This measurement is to be taken at the nearest V<sub>REF</sub> bypass capacitor.
7. V<sub>TT</sub> is not applied directly to the device. V<sub>TT</sub> is a system supply for signal termination resistors, is expected to be set equal to V<sub>REF</sub> and must track variations in the DC level of V<sub>REF</sub>.
8. I<sub>DD</sub> is dependent on output loading and cycle rates. Specified values are obtained with mini-mum cycle time at CL = 2 for 262 and 202, CL = 2.5 for 335 and 265 with the outputs open.
9. Enables on-chip refresh and address counters.
10. I<sub>DD</sub> specifications are tested after the device is properly initialized, and is averaged at the defined cycle rate.
11. This parameter is sampled. V<sub>CC</sub> = +2.5V ±0.2V, V<sub>CCQ</sub> = +2.5V ±0.2V, V<sub>REF</sub> = V<sub>SS</sub>, f = 100 MHz, TA = 25°C, V<sub>OUT(DC)</sub> = V<sub>CCQ2</sub>, V<sub>OUT</sub> (peak to peak) = 0.2V. DM input is grouped with I/O pins, reflecting the fact that they are matched in loading.
12. For slew rates < 1 V/ns and ≥ 0.5 V/ns. If the slew rate is < 0.5V/ns, timing must be derated: t<sub>IS</sub> has an additional 50ps per each 100 mV/ns reduction in slew rate from 500 mV/ns, while t<sub>IH</sub> is unaffected. If the slew rate exceeds 4.5 V/ns, functionality is uncertain. For 335, slew rates must be 0.5 V/ns.
13. The CK/CK# input reference level (for timing referenced to CK/CK#) is the point at which CK and CK# cross; the input reference level for signals other than CK/CK# is V<sub>REF</sub>.
14. Inputs are not recognized as valid until V<sub>REF</sub> stabilizes. Exception: during the period before V<sub>REF</sub> stabilizes, CKE < 0.3 x V<sub>CC0</sub> is recognized as LOW.
15. The output timing reference level, as measured at the timing reference point indicated in Note 3, is V<sub>TT</sub>.
16. t<sub>HZ</sub> and t<sub>LZ</sub> transitions occur in the same access time windows as data valid transitions. These parameters are not referenced to a specific voltage level, but specify when the device output is no longer driving (HZ) or begins driving (LZ).

17. The intent of the Don't Care state after completion of the postamble is the DQS-driven signal should either be high, low, or high-Z and that any signal transition within the input switching region must follow valid input requirements. That is, if DQS transitions high [above V<sub>IHDC</sub> (MIN)] then it must not transition low (below V<sub>IHDC</sub>) prior to t<sub>DQSH</sub> (MIN).
18. This is not a device limit. The device will operate with a negative value, but system performance could be degraded due to bus turnaround.
19. It is recommended that DQS be valid (HIGH or LOW) on or before the WRITE command. The case shown (DQS going from High-Z to logic LOW) applies when no WRITES were previously in progress on the bus. If a previous WRITE was in progress, DQS could be HIGH during this time, depending on t<sub>DQSS</sub>.
20. MIN (t<sub>RC</sub> or t<sub>RF</sub>) for I<sub>DD</sub> measurements is the smallest multiple of t<sub>CK</sub> that meets the minimum absolute value for the respective parameter. t<sub>RAS</sub> (MAX) for I<sub>DD</sub> measurements is the largest multiple of t<sub>CK</sub> that meets the maximum absolute value for t<sub>RAS</sub>.
21. The refresh period 64ms. This equates to an average refresh rate of 7.8251μs. However, an AUTO REFRESH command must be asserted at least once every 70.3μs; burst refreshing or posting by the DRAM controller greater than eight refresh cycles is not allowed.
22. The valid data window is derived by achieving other specifications: t<sub>HP</sub> (t<sub>CK2</sub>), t<sub>DQSO</sub>, and t<sub>QH</sub> (t<sub>QH</sub> = t<sub>HP</sub> - t<sub>QHS</sub>). The data valid window derates in direct proportion with the clock duty cycle and a practical data valid window can be derived, as shown in Figure 7, Derating Data Valid Window. The clock is allowed a maximum duty cycle variation of 45/55, beyond which functionality is uncertain. The data valid window derating curves are provided below for duty cycles ranging between 50/50 and 45/55.
23. Each byte lane has a corresponding DQS.
24. This limit is actually a nominal value and does not result in a fail value. CKE is HIGH during REFRESH command period (t<sub>RF</sub> [MIN]) else CKE is LOW (i.e., during standby).
25. To maintain a valid level, the transitioning edge of the input must:
  - a. Sustain a constant slew rate from the current AC level through to the target AC level, V<sub>IL</sub>(AC) or V<sub>IH</sub>(AC).
  - b. Reach at least the target AC level.
  - c. After the AC target level is reached, continue to maintain at least the target DC level, V<sub>IL</sub>(DC) or V<sub>IH</sub>(DC).
26. JEDEC specifies CK and CK# input slew rate must be ≤ 1V/ns (2V/ns differentially).
27. DQ and DM input slew rates must not deviate from DQS by more than 10 percent. If the DQ/DM/DQS slew rate is less than 0.5 V/ns, timing must be derated: 50ps must be added to t<sub>DS</sub> and t<sub>DH</sub> for each 100 mV/ns reduction in slew rate. If slew rate exceeds 4 V/ns, functionality is uncertain. For 335, slew rates must be ≥ 0.5 V/ns.
28. V<sub>CC</sub> must not vary more than 4 percent if CKE is not active while any bank is active.
29. The clock is allowed up to ±150ps of jitter. Each timing parameter is allowed to vary by the same amount.
30. t<sub>HP</sub> min is the lesser of t<sub>CL</sub> minimum and t<sub>CH</sub> minimum actually applied to the device CK and CK# inputs, collectively during bank active.
31. READs and WRITEs with auto precharge are not allowed to be issued until t<sub>RAS</sub>(min) can be satisfied prior to the internal precharge command being issued.
32. Any positive glitch must be less than 1/3 of the clock and not more than +400mV or 2.9V, whichever is less. Any negative glitch must be less than 1/3 of the clock cycle and not exceed either -300mV or 2.2V, whichever is more positive.
33. The voltage levels used are derived from a mini-mum V<sub>CC</sub> level and the referenced test load. In practice, the voltage levels obtained from a properly terminated bus will provide significantly different voltage values.

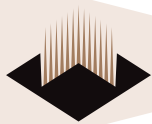

34.  $V_{IH}$  overshoot:  $V_{IH}(MAX) = V_{CCQ} + 1.5V$  for a pulse width  $\leq 3ns$  and the pulse width can not be greater than 1/3 of the cycle rate.  $V_{IL}$  undershoot:  $V_{IL}(MIN) = -1.5V$  for a pulse width  $\leq 3ns$  and the pulse width can not be greater than 1/3 of the cycle rate.
35.  $V_{CC}$  and  $V_{CCQ}$  must track each other.
36.  $t_{HZ}(MAX)$  will prevail over  $t_{DQSK}(MAX) + t_{RPST}(MAX)$  condition.  $t_{LZ}(MIN)$  will prevail over  $t_{DQSK}(MIN) + t_{RPRE}(MAX)$  condition.
37.  $t_{RPST}$  end point and  $t_{RPRE}$  begin point are not referenced to a specific voltage level but specify when the device output is no longer driving ( $t_{RPST}$ ), or begins driving ( $t_{RPRE}$ ).
39. During initialization,  $V_{CCQ}$ ,  $V_{TT}$ , and  $V_{REF}$  must be equal to or less than  $V_{CC} + 0.3V$ . Alternatively,  $V_{TT}$  may be 1.35V maximum during power up, even if  $V_{CC}/V_{CCQ}$  are 0Vs, provided a minimum of 42  $\Omega$  of series resistance is used between the  $V_{TT}$  supply and the input pin.
40. The current part operates below the slowest JEDEC operating frequency of 83 MHz. As such, future die may not reflect this option.
41. Random addressing changing and 50 percent of data changing at every transfer.
42. Random addressing changing and 100 percent of data changing at every transfer.
43. CKE must be active (high) during the entire time a refresh command is executed. That is, from the time the AUTO REFRESH command is registered, CKE must be active at each rising clock edge, until  $t_{REF}$  later.
44.  $I_{DD2N}$  specifies the DQ, DQS, and DM to be driven to a valid high or low logic level.  $I_{DD2Q}$  is similar to  $I_{DD2F}$  except  $I_{DD2Q}$  specifies the address and control inputs to remain stable. Although  $I_{DD2F}$ ,  $I_{DD2N}$ , and  $I_{DD2Q}$  are similar,  $I_{DD2F}$  is "worst case."
45. Whenever the operating frequency is altered, not including jitter, the DLL is required to be reset. This is followed by 200 clock cycles.
46. Leakage number reflects the worst case leakage possible through the module pin, not what each memory device contributes.
47. When an input signal is HIGH or LOW, it is defined as a steady state logic HIGH or LOW.
48. The 335 speed grade will operate with  $t_{RAS}(MIN) = 40ns$  and  $t_{RAS}(MAX) = 120,000ns$  at any slower frequency.

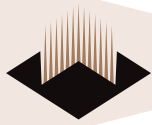

## ORDERING INFORMATION FOR BD4

Part Number	Speed	Height*
W3EG7232S335xBD4xxx	166MHz/333Mbps, CL=2.5	31.75 (1.25")
W3EG7232S262xBD4xxx	133MHz/266Mbps, CL=2	31.75 (1.25")
W3EG7232S265xBD4xxx	133MHz/266Mbps, CL=2.5	31.75 (1.25")
W3EG7232S202xBD4xxx	100MHz/200Mbps, CL=2	31.75 (1.25")

### NOTES:

- Consult Factory for availability of RoHS compliant products. (G = RoHS Compliant)
- Vendor specific part numbers are used to provide memory components source control. The place holder for this is shown as lower case "x" in the part numbers above and is to be replaced with the respective vendors code. Consult factory for qualified sourcing options. (M = Micron, S = Samsung & consult factory for others)
- Consult factory for availability of industrial temperature (-40°C to 85°C) option
- For part numbering interpretation, please see "part numbering guide" on page 13

## PACKAGE DIMENSIONS FOR BD4

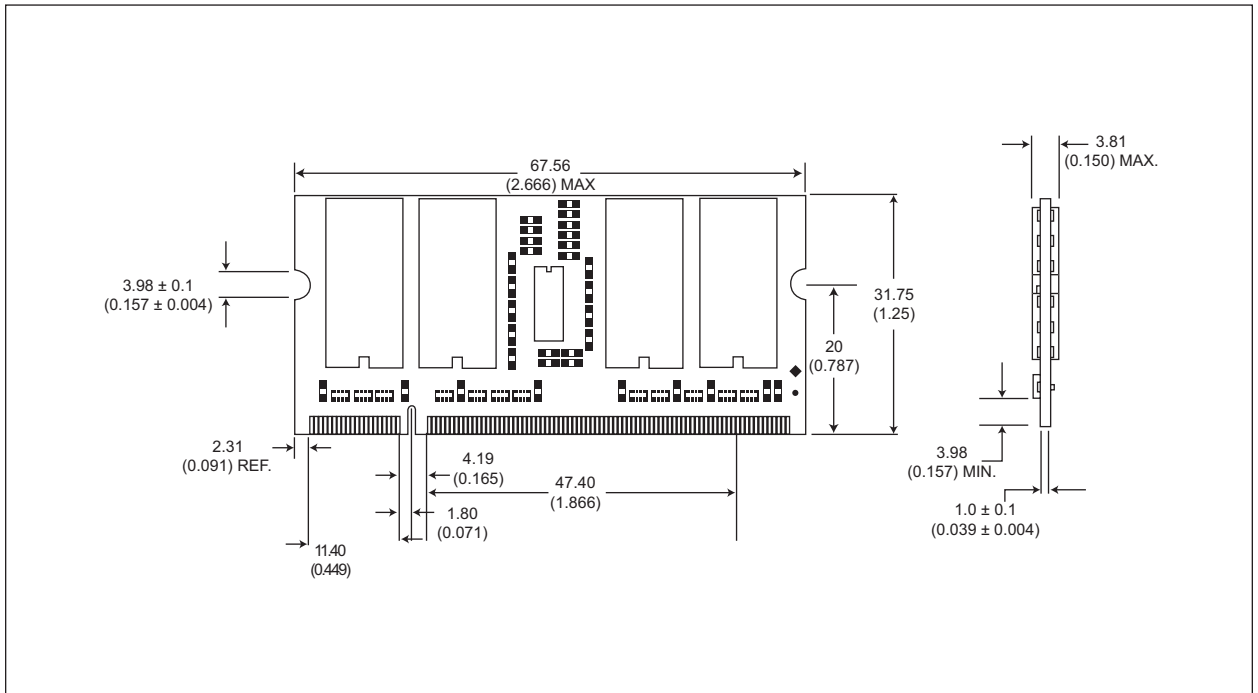

\* ALL DIMENSIONS ARE IN MILLIMETERS AND (INCHES)

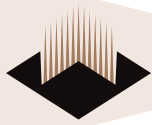

## ORDERING INFORMATION FOR AD4

Part Number	Speed	Height*
W3EG7232S335xAD4xxx	166MHz/333Mbps, CL=2	35.05 (1.38")
W3EG7232S262xAD4xxx	133MHz/266Mbps, CL=2	35.05 (1.38")
W3EG7232S265xAD4xxx	133MHz/266Mbps, CL=2.5	35.05 (1.38")
W3EG7232S202xAD4xxx	100MHz/200Mbps, CL=2	35.05 (1.38")

### NOTES:

- Consult Factory for availability of RoHS compliant products. (G = RoHS Compliant)
- Vendor specific part numbers are used to provide memory components source control. The place holder for this is shown as lower case "x" in the part numbers above and is to be replaced with the respective vendors code. Consult factory for qualified sourcing options. (M = Micron, S = Samsung & consult factory for others)
- Consult factory for availability of industrial temperature (-40°C to 85°C) option
- For part numbering interpretation, please see "part numbering guide" on page 13

## PACKAGE DIMENSIONS FOR AD4

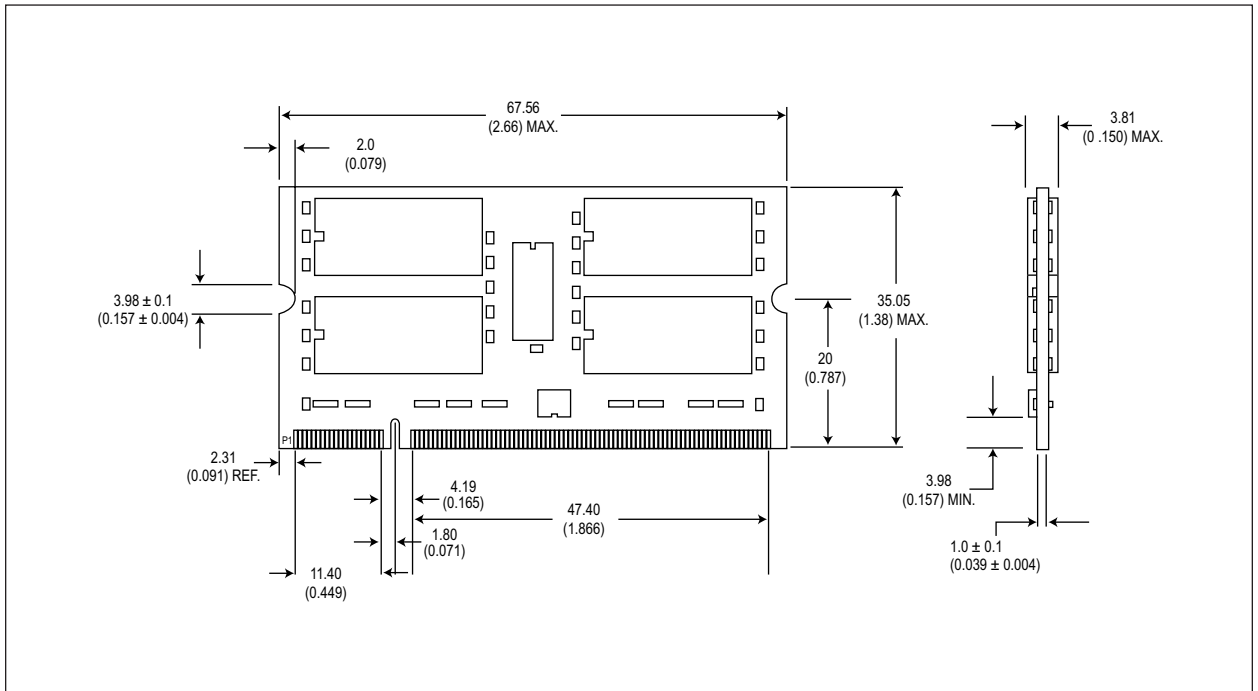

\* ALL DIMENSIONS ARE IN MILLIMETERS AND (INCHES)

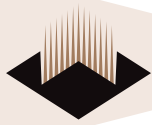

PART NUMBERING GUIDE

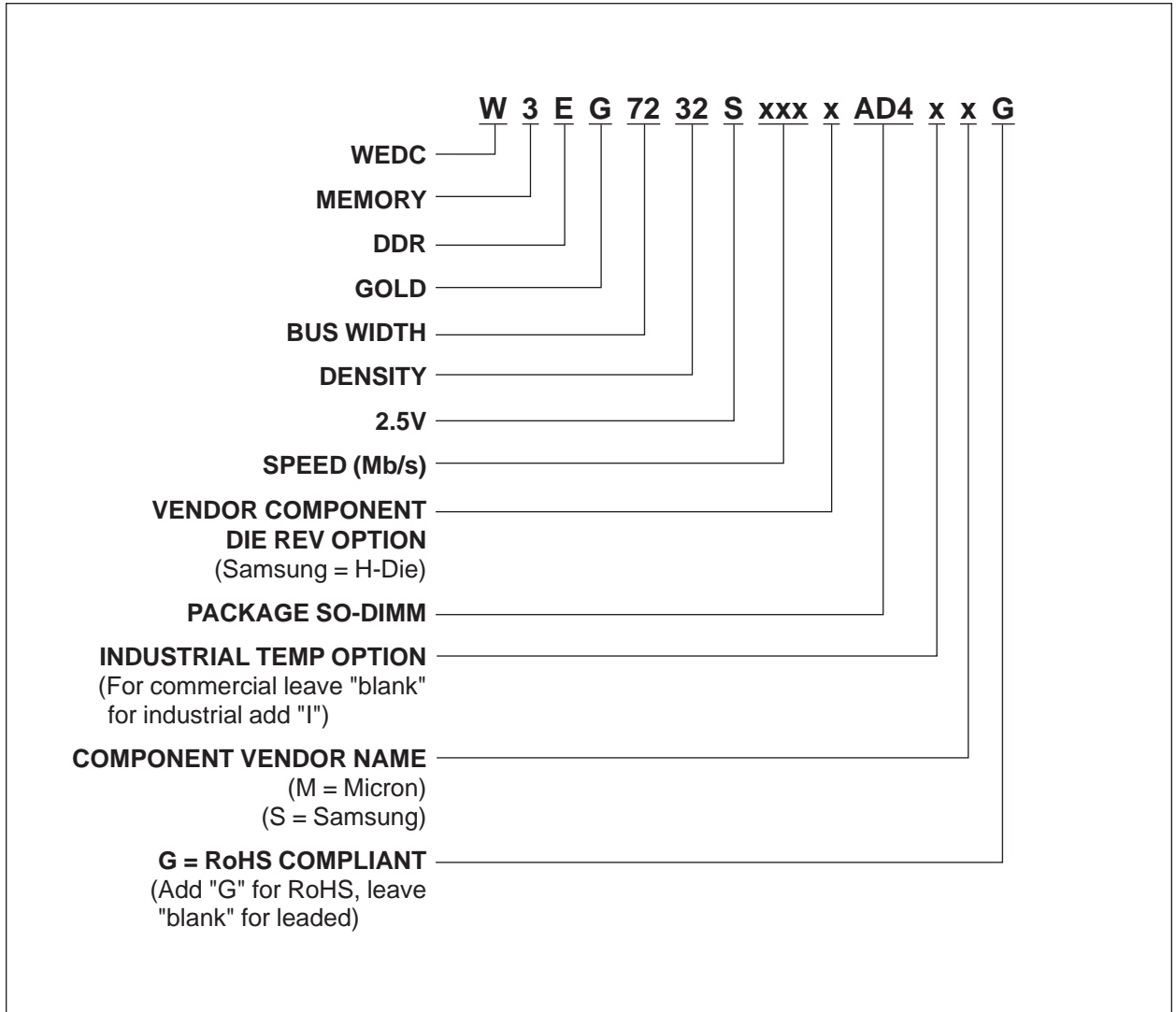

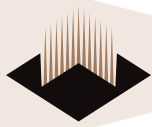

## Document Title

256MB – 32Mx72, DDR SDRAM Unbuffered ECC, w/PLL

## Revision History

Rev #	History	Release Date	Status
Rev 0	Initial Release	7-24-03	Advanced
Rev 1	1.1 Added "BD4" package height option	4-04	Preliminary
Rev 2	2.1 Added 333MHz Speed	10-22-04	Preliminary
Rev 3	3.1 Added lead-free and RoHS notes 3.2 Added source control notes 3.3 Added industrial temperature options	1-05	Preliminary
Rev 4	4.1 Removed "ED" to reduce the number of characters 4.2 Added part number matrix	8-05	Preliminary
Rev 5	5.1 Updated part numbering guide 5.2 Added component die rev 5.3 Added industrial temp option to part numbering guide 5.4 Moved from preliminary to final	3-07	Final