

PTF 10112

60 Watts, 1.8–2.0 GHz

GOLDMOS™ Field Effect Transistor

Description

The PTF 10112 is an internally matched common source N-channel enhancement-mode lateral MOSFET intended for CDMA and TDMA applications from 1.8 to 2.0 GHz. It is rated at 60 watts power output. Nitride surface passivation and full gold metallization ensure excellent device lifetime and reliability.

- **INTERNALLY MATCHED**
- **Guaranteed Performance at 1.93, 1.99 GHz, 28 V**
 - Output Power = 60 Watts Min
 - Power Gain = 12 dB Typ
- **Full Gold Metallization**
- **Silicon Nitride Passivated**
- **Back Side Common Source**
- **Excellent Thermal Stability**
- **100% Lot Traceability**

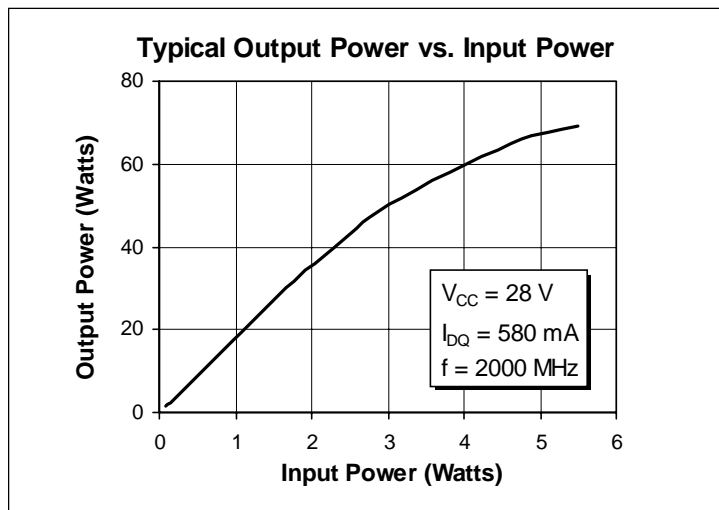

Package 20248

RF Specifications (100% Tested)

Characteristic	Symbol	Min	Typ	Max	Units
Gain ($V_{DD} = 28\text{ V}$, $P_{OUT} = 15\text{ W}$, $I_{DQ} = 580\text{ mA}$, $f = 1.93, 1.99\text{ GHz}$)	G_{ps}	11	12	—	dB
Power Output at 1 dB Compression ($V_{DD} = 28\text{ V}$, $I_{DQ} = 580\text{ mA}$, $f = 1.99\text{ GHz}$)	P-1dB	60	—	—	Watts
Drain Efficiency ($V_{DD} = 28\text{ V}$, $P_{OUT} = 60\text{ W}$, $I_{DQ} = 580\text{ mA}$, $f = 1.99\text{ GHz}$)	η_D	—	41	—	%
Load Mismatch Tolerance ($V_{DD} = 28\text{ V}$, $P_{OUT} = 60\text{ W}$, $I_{DQ} = 580\text{ mA}$, $f = 1.99\text{ GHz}$ —all phase angles at frequency of test)	Ψ	—	—	10:1	—

All published data at $T_{CASE} = 25^\circ\text{C}$ unless otherwise indicated.

Electrical Characteristics (100% Tested)

Characteristic	Conditions	Symbol	Min	Typ	Max	Units
Drain-Source Breakdown Voltage	$V_{GS} = 0\text{ V}, I_D = 100\text{ mA}$	$V_{(BR)DSS}$	65	—	—	Volts
Zero Gate Voltage Drain Current	$V_{DS} = 28\text{ V}, V_{GS} = 0\text{ V}$	I_{DSS}	—	—	5.0	mA
Gate Threshold Voltage	$V_{DS} = 10\text{ V}, I_D = 150\text{ mA}$	$V_{GS(th)}$	3.0	—	5.0	Volts
Forward Transconductance	$V_{DS} = 10\text{ V}, I_D = 2\text{ A}$	g_{fs}	—	4.0	—	Siemens

Maximum Ratings

Parameter	Symbol	Value	Unit
Drain-Source Voltage	V_{DSS}	65	Vdc
Gate-Source Voltage	V_{GS}	± 20	Vdc
Operating Junction Temperature	T_J	200	$^{\circ}\text{C}$
Total Device Dissipation at Above 25°C derate by	P_D	237 1.35	Watts $\text{W}/^{\circ}\text{C}$
Storage Temperature Range	T_{STG}	-40 to +150	$^{\circ}\text{C}$
Thermal Resistance ($T_{CASE} = 70^{\circ}\text{C}$)	$R_{\theta JC}$	0.74	$^{\circ}\text{C}/\text{W}$

Typical Performance

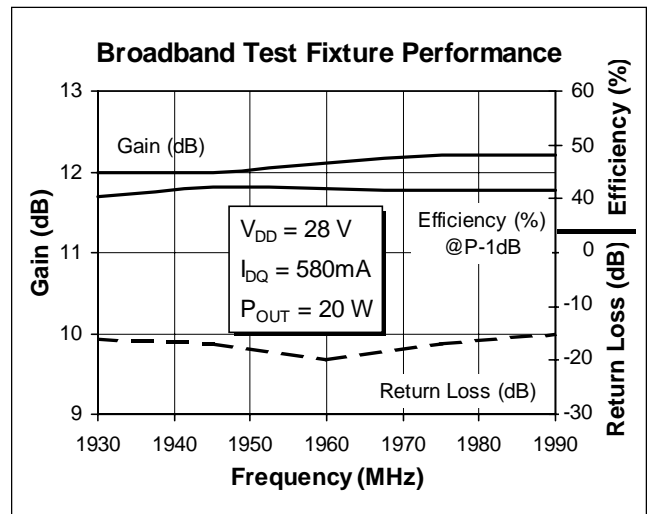
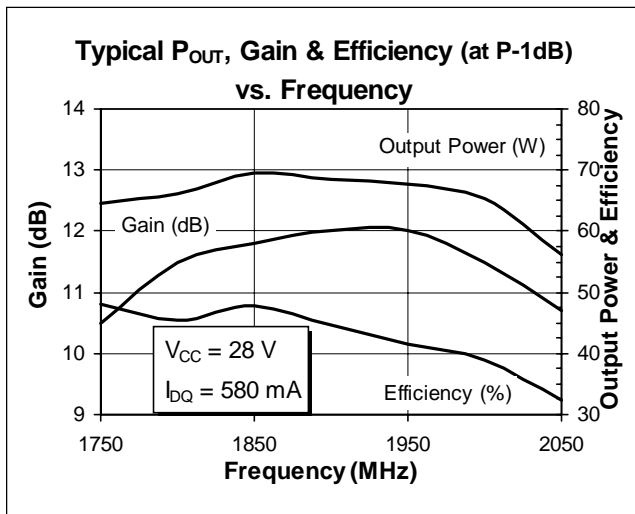

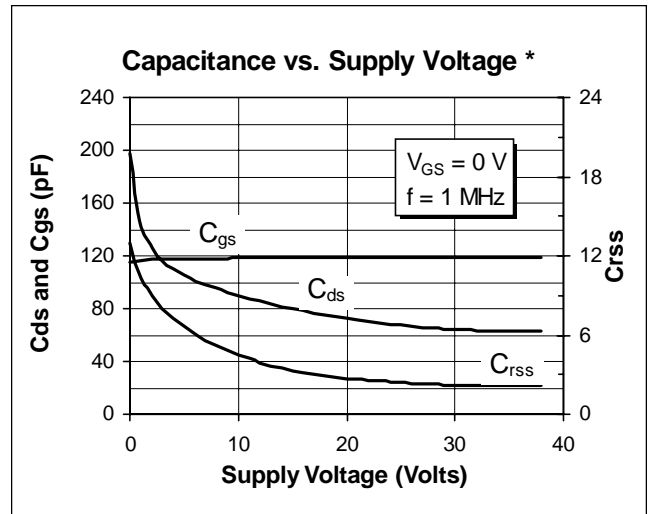
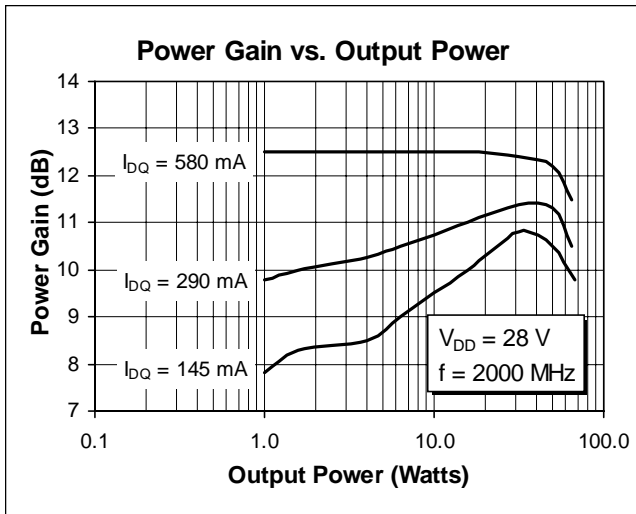
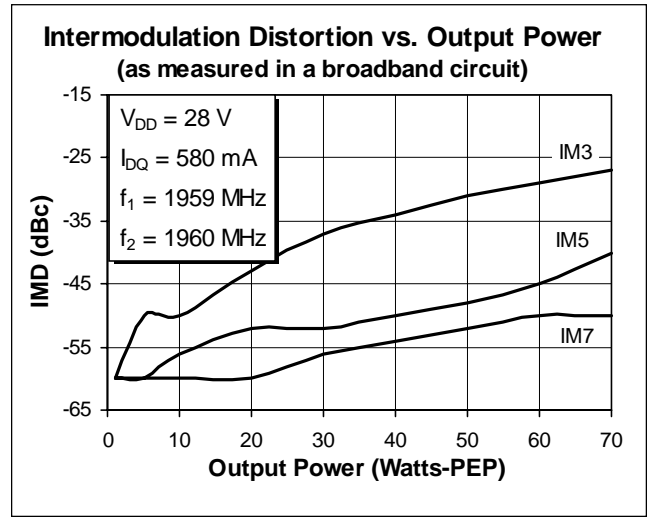
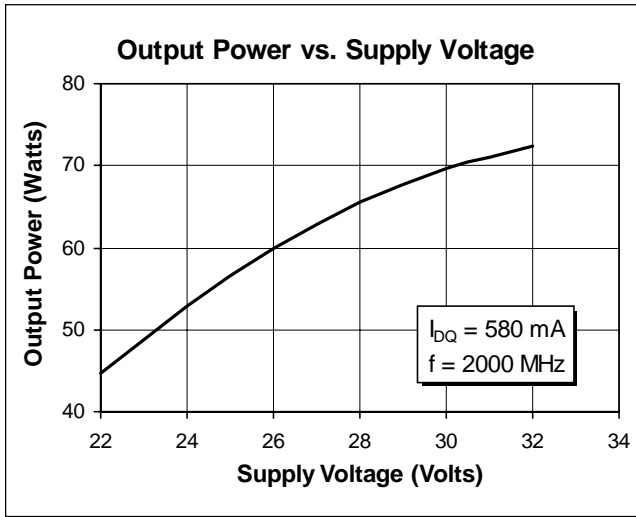

* This part is internally matched. Measurements of the finished product will not yield these results.

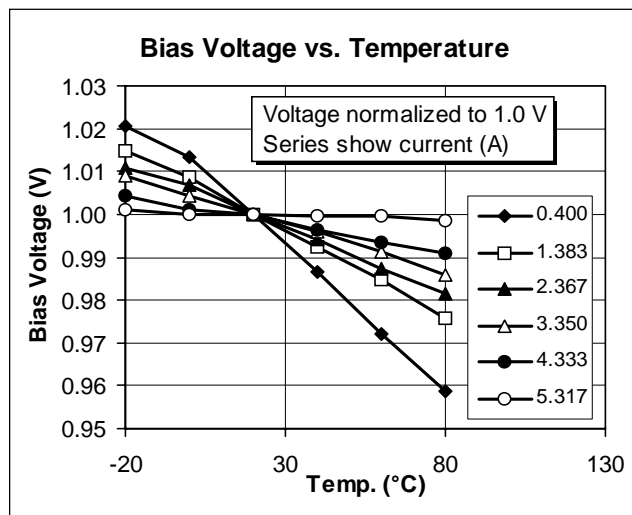

PTF 10112



Impedance Data

$V_{DD} = 28\text{ V}$, $P_{OUT} = 60\text{ W}$, $I_{DQ} = 580\text{ mA}$

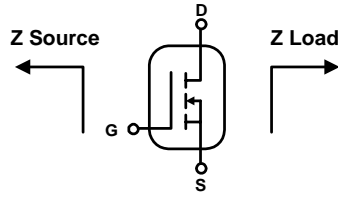

Frequency	Z Source Ω		Z Load Ω	
	GHz	R	jX	R
1.75	3.74	-4.50	1.48	0.25
1.80	3.80	-4.80	1.56	-0.20
1.85	3.96	-5.10	1.66	-0.50
1.90	4.90	-5.50	1.32	-0.80
1.95	7.90	-6.10	1.16	-0.60
2.00	9.00	-4.60	1.10	-0.45
2.05	10.00	-1.70	1.18	-0.30

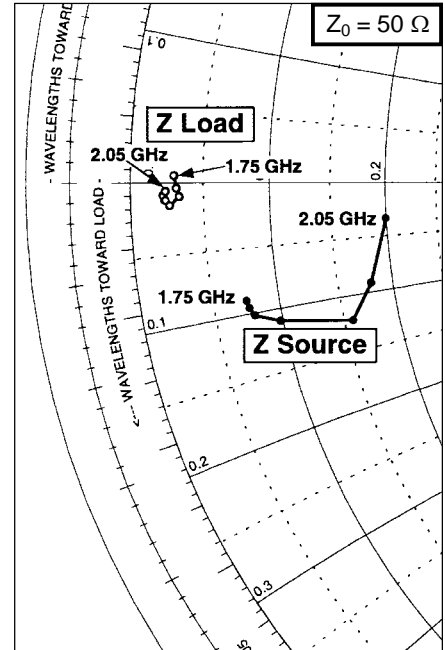

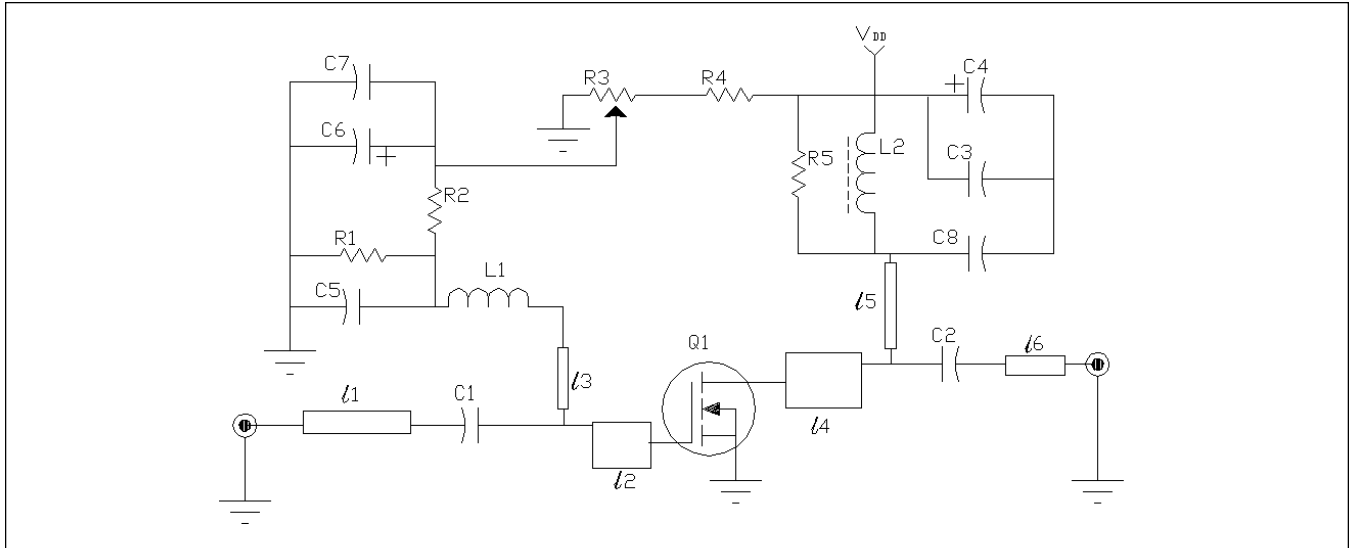

Test Circuit

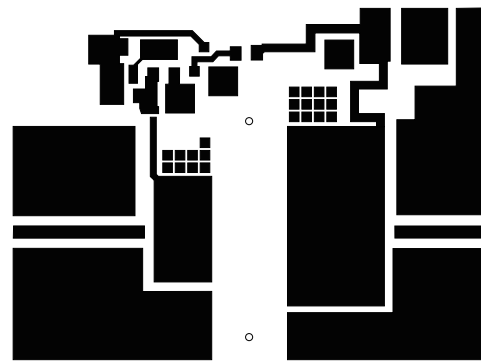
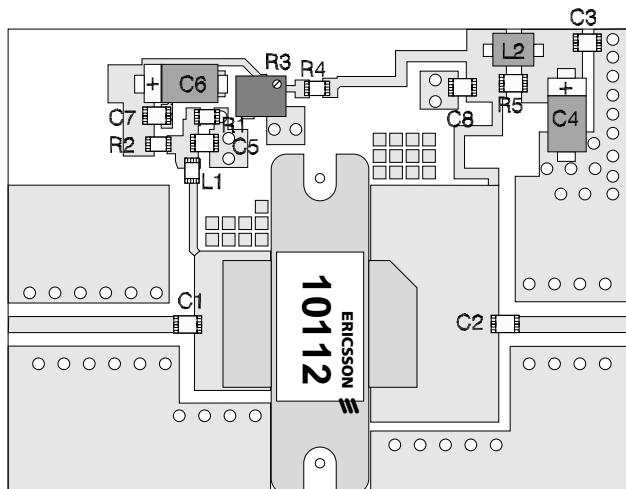

Test Circuit Block Diagram for $f = 1.93\text{--}1.99\text{ GHz}$

Q1	PTF 10112	LDMOS RF Transistor	L1	2.7 nh	SMT Coil
l1, l6		Microstrip 50 Ω	L2	4mm	SMT Ferrite Bead
l2	.10 λ @ 2.0 GHz	Microstrip 9.4 Ω	R1, R2	220 Ω	Chip Resistor K1206
l3	.08 λ @ 2.0 GHz	Microstrip 70 Ω	R3	2K	SMT Potentiometer
l4	.162 λ @ 2.0 GHz	Microstrip 5.8 Ω	R4	10 Ω	Chip Resistor K1206
l5	.22 λ @ 2 GHz	Microstrip 65 Ω	R5	1 Ω	Chip Resistor K1206
C1, C2, C5, C8	10 pF Chip Cap	ATC 100 B	Circuit Board	.028" Dielectric Thickness, $\epsilon_r = 4.0$, AlliedSignal, G200, 2 oz. copper	
C3, C7	0.1 μF Chip Cap				
C4, C6	10 μF SMT Tantalum				



Artwork (1 inch )

Parts Layout (not to scale)

Notes: