

PN Unijunction Transistors

Silicon Unijunction Transistors

... designed for pulse and timing circuits, sensing circuits, and thyristor trigger circuits. These devices feature:

- Low Peak Point Current — 1 μ A Typical
- Low Emitter Reverse Current — 5 nA Typical
- Passivated Surface for Reliability and Uniformity
- One-Piece Injection-Molded Unibloc[®] Plastic Package for Economy and Reliability
- High η for greater bandwidth

2N4870
2N4871

PN UJTs

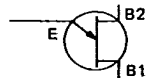

Boca Semiconductor Corp.

BSC

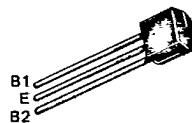

CASE 29-04
(TO-226AA)
STYLE 9

MAXIMUM RATINGS ($T_A = 25^\circ$ unless otherwise noted.)

Rating	Symbol	Value	Unit
RMS Power Dissipation, Note 1	P_D	300	mW
RMS Emitter Current	I_e	50	mA
Peak-Pulse Emitter Current, Note 2	i_e	1.5	Amp
Emitter Reverse Voltage	V_{B2E}	30	Volts
Interbase Voltage, Note 3	V_{B2B1}	35	Volts
Operating Junction Temperature Range	T_J	-55 to +125	$^\circ$ C
Storage Temperature Range	T_{stg}	-55 to +150	$^\circ$ C

- Notes: 1. Derate 3 mW/ $^\circ$ C increase in ambient temperature.
2. Duty cycle \leq 1%, PRR = 10 PPS (see Figure 5).
3. Based upon power dissipation at $T_A = 25^\circ$ C.

<http://www.bocasemi.com>

T-37-21

ELECTRICAL CHARACTERISTICS ($T_A = 25^\circ\text{C}$ unless otherwise noted.)

Characteristic	Fig. No.	Symbol	Min	Typ	Max	Unit
Intrinsic Standoff Ratio, Note 1 ($V_{B2B1} = 10\text{ V}$)	4, 7	η	0.56 0.70	—	0.75 0.85	—
Interbase Resistance ($V_{B2B1} = 3\text{ V}, I_E = 0$)	10, 11	R_{BB}	4	6	9.1	k ohms
Interbase Resistance Temperature Coefficient ($V_{B2B1} = 3\text{ V}, I_E = 0, T_A = -65\text{ to }+125^\circ\text{C}$)	11	αR_{BB}	0.10	—	0.90	%/°C
Emitter Saturation Voltage, Note 2 ($V_{B2B1} = 10\text{ V}, I_E = 50\text{ mA}$)		$V_{EB1}(\text{sat})$	—	2.5	—	Volts
Modulated Interbase Current ($V_{B2B1} = 10\text{ V}, I_E = 50\text{ mA}$)		$I_{B2}(\text{mod})$	—	15	—	mA
Emitter Reverse Current ($V_{B2E} = 30\text{ V}, I_{B1} = 0$)	6	I_{EB20}	—	0.005	1	μA
Peak-Point Emitter Current ($V_{B2B1} = 25\text{ V}$)	8, 9	I_P	—	1	5	μA
Valley-Point Current, Note 2 ($V_{B2B1} = 20\text{ V}, R_{B2} = 100\text{ ohms}$)	12, 13	I_V	2 4	5 7	—	mA
Base-One Peak Pulse Voltage	2N4870 2N4871	V_{OB1}	3 5	6 8	—	Volts

Notes: 1. η , Intrinsic standoff ratio, is defined in terms of the peak-point voltage, V_P , by means of the equation: $V_P = \eta V_{B2B1} + V_F$, where V_F is about 0.49 volt at 25°C ($I_F = 10\text{ mA}$) and decreases with temperature at about $2.5\text{ mV}/^\circ\text{C}$. The test circuit is shown in Figure 4. Components R_1, C_1 , and the UJT form a relaxation oscillator; the remaining circuitry serves as a peak-voltage detector. The forward drop of Diode D_1 compensates for V_P . To use, the "cal" button is pushed, and R_3 is adjusted to make the current meter, M_1 , read full scale. When the "cal" button is released, the value of η is read directly from the meter, if full scale on the meter reads 1.

2. Use pulse techniques: $PW \approx 300\text{ }\mu\text{s}$, duty cycle $\leq 2\%$ to avoid internal heating, which may result in erroneous readings.



FIGURE 1 — UNIJUNCTION TRANSISTOR SYMBOL AND NOMENCLATURE

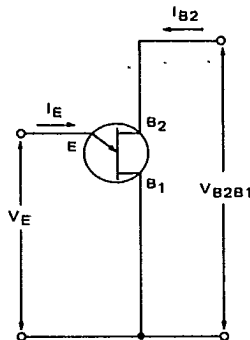

FIGURE 2 — STATIC EMITTER CHARACTERISTICS CURVES

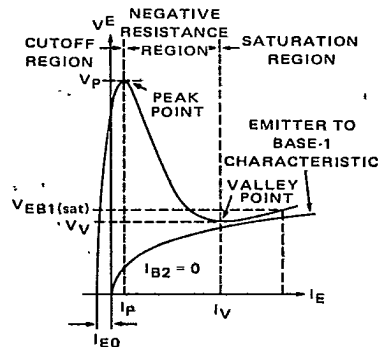

FIGURE 3 - V_{OB1} TEST CIRCUIT

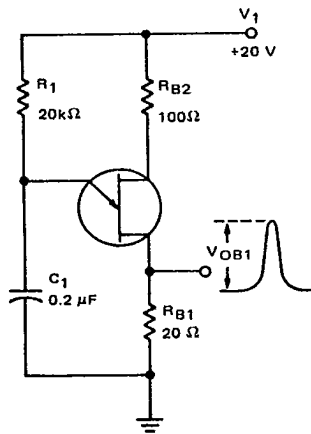

FIGURE 4 - η TEST CIRCUIT

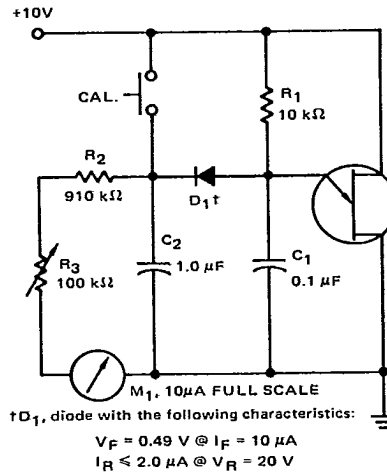
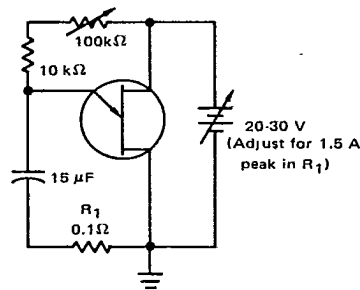
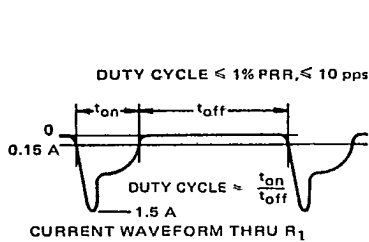

FIGURE 5 - PRR TEST CIRCUIT AND WAVEFORM



TYPICAL CHARACTERISTICS

FIGURE 6 - EMITTER REVERSE CURRENT

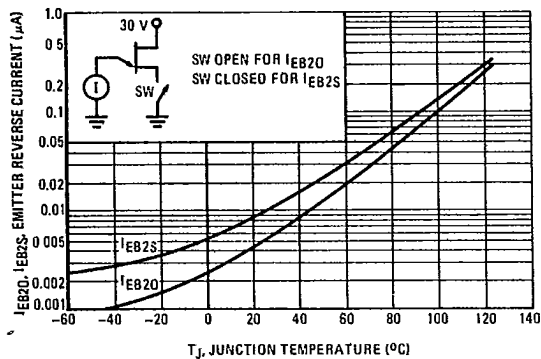
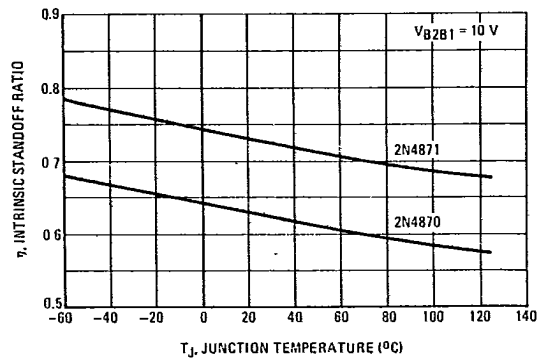

FIGURE 7 - INTRINSIC STANDOFF RATIO



PEAK POINT CURRENT

FIGURE 8 — EFFECT OF VOLTAGE

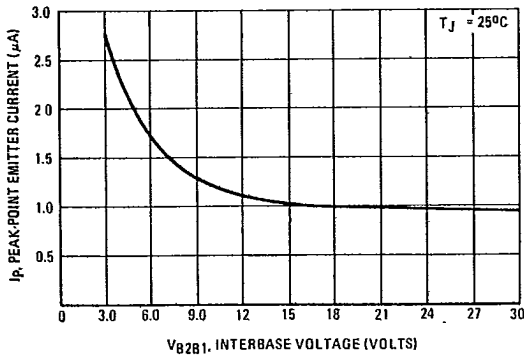
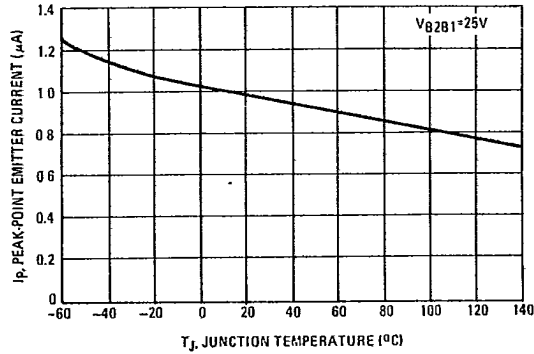

FIGURE 9 — EFFECT OF TEMPERATURE



INTERBASE RESISTANCE

FIGURE 10 — EFFECT OF VOLTAGE

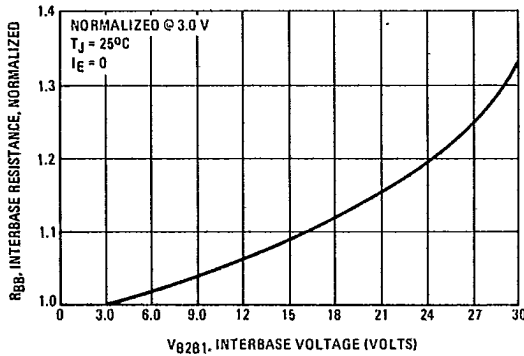
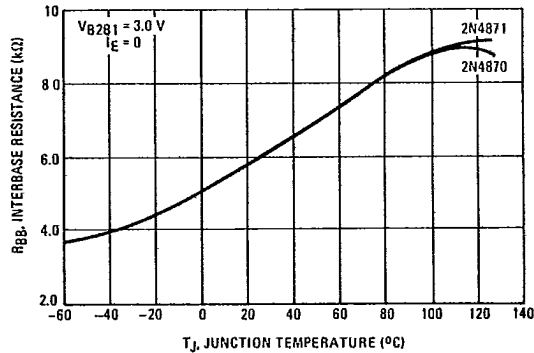

FIGURE 11 — EFFECT OF TEMPERATURE



TYPICAL CHARACTERISTICS

<http://www.bocasemi.com>

VALLEY CURRENT

FIGURE 12 — EFFECT OF VOLTAGE

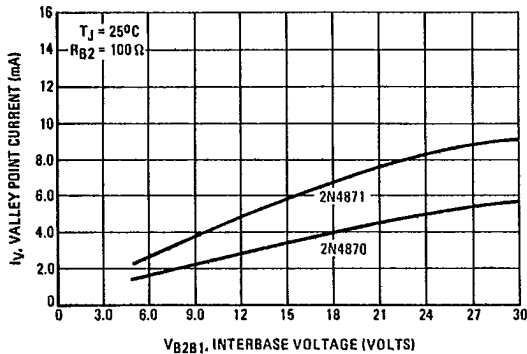
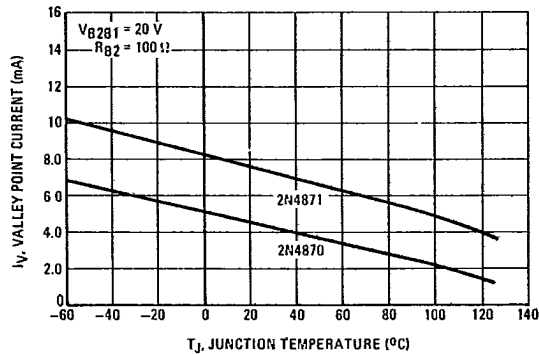

FIGURE 13 — EFFECT OF TEMPERATURE



2N4870 • 2N4871

T-37-21

VALLEY VOLTAGE

FIGURE 14 - EFFECT OF VOLTAGE

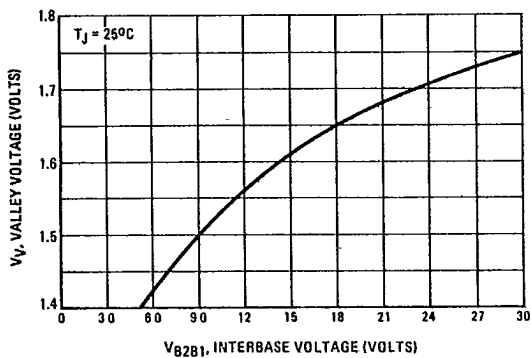

FIGURE 15 - EFFECT OF TEMPERATURE

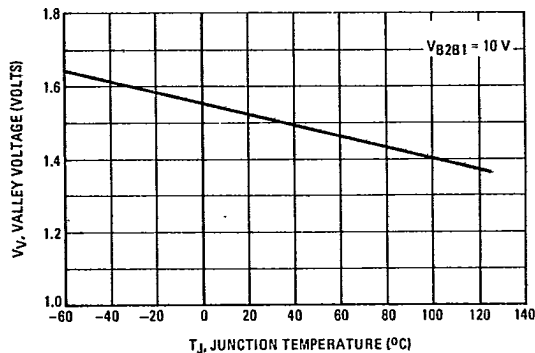

FIGURE 16 - OUTPUT VOLTAGE

