

R-11-040AX-P-SXX/XXX-X-XX



Features

- InGaAs/InP PIN Photodiode
- High responsivity at 1310nm and 1550nm
- Low dark current
- Low intermodulation distortion
- High responsivity
- Hermetically sealed 3-pin metal case

Packaging

- SM fiber pigtailed with optional FC/ST/SC/APC connector

Application

- Return path Analog CATV Optical Receivers to 2.5GHz
- RoHS compliant available

Absolute Maximum Ratings (Tc=25°C)

Parameter	Symbol	Value	Unit
Supply Reverse Voltage	V_R	20	V
Forward Current	I_F	2	mA
Reverse Current	I_R	1	mA
Operating Temperature	T_{opr}	-40 ~ 85	°C
Storage Temperature	T_{stg}	-40 ~ 100	°C

(All optical data refer to a coupled 9/125µm SM fiber)

Optical and Electrical Characteristics (Tc=25°C)

Parameter	Symbol	Min	Typ	Max	Unit	Test Conditions
Operating Voltage	V_{op}	-	-	15	V	-
Detection Range		1100	1310	1650	nm	-
Responsivity	R	0.75 0.8	0.8 0.9	- -	AW	$V_R=5V, \lambda=1310nm$ $V_R=5V, \lambda=1550nm$
Linearity IMD2	IMD2	-	-70	-	dBc	Note1
Dark Current	I_{dark}	-	-	0.8	nA	$V_R=5V$
Capacitance	C	-	-	0.35	pF	Note2
Rise / Fall Time	T_r / T_f	-	-	0.125	ns	$V_R=5V, 10\% \sim 90\%$
Bandwidth	BW	8	-	-	GHz	$V_R=5V$
Optical Return Loss	ORL	40	-	-	dB	$\lambda=1310nm$

Note: 1. $V_R=12V, P_{AVG}=0dBm, MI=0.7, R_{LOAD}=50ohm, f_1+f_2=324.25MHz, f_1-f_2=54.25MHz$

2. $V_R=5V, Case grounded$

R-11-040AX-P-SXX/XXX-X-XX

Pin Assignment

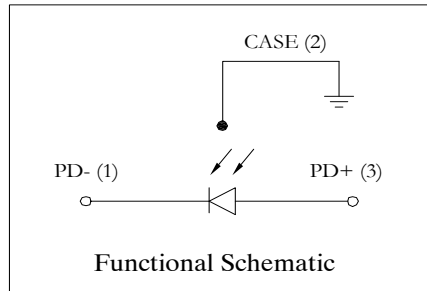

Pin Assignment

- 1~PD (-)
- 2~CASE
- 3~PD (+)

Packaging Dimension

Units in mm.

Pin Assignment

A Type

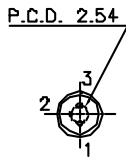

B Type

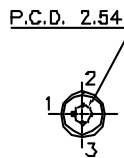

Flange Type

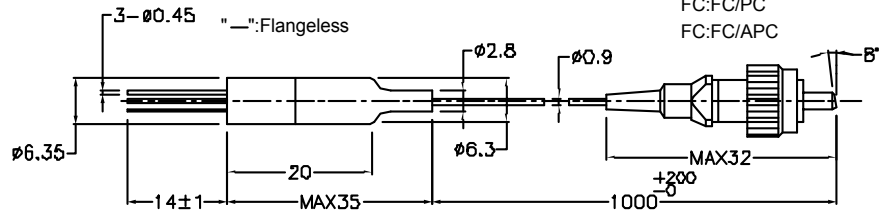

Connector Type

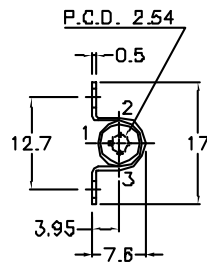
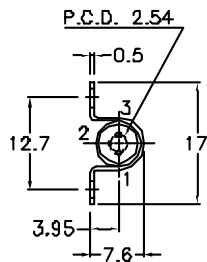

"O":Horizontal (Omega Housing)

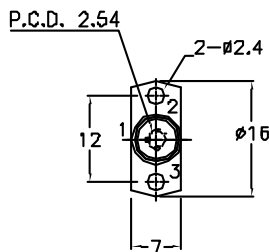
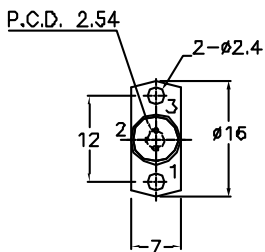
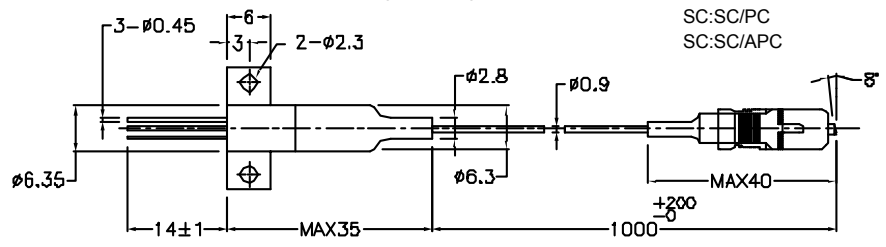

"V":Vertical

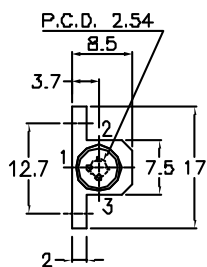
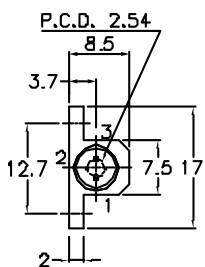
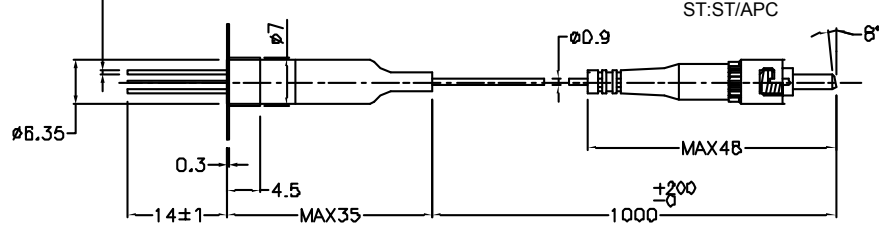

"K":Horizontal (KX Housing)

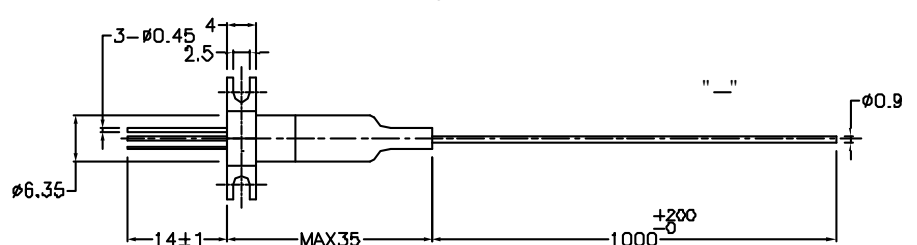

R-11-040AX-P-SXX/XXX-X-XX

Ordering Information

R-11-040AX-P-SXX/XXX-X-XX

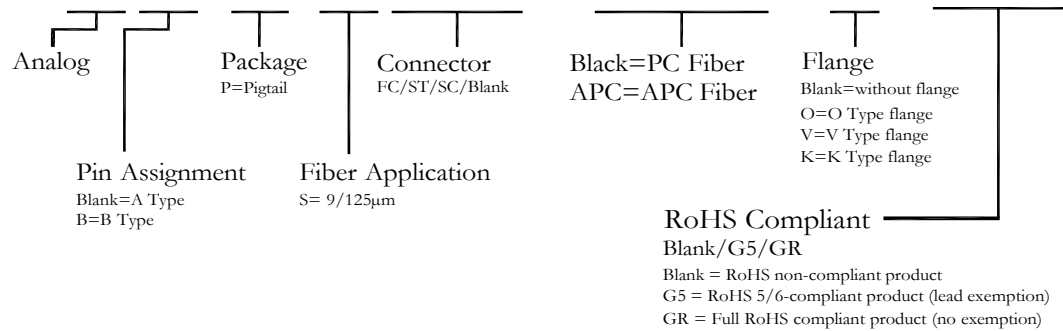

Warnings

Handling Precautions: This device is susceptible to damage as a result of electrostatic discharge (ESD). A static free environment is highly recommended. Follow guidelines according to proper ESD procedures.
Laser Safety: Radiation emitted by laser devices can be dangerous to human eyes. Avoid eye exposure to direct or indirect radiation.

Legal Notice

IMPORTANT NOTICE!
All information contained in this document is subject to change without notice, at Luminent's sole and absolute discretion. Luminent warrants performance of its products to current specifications only in accordance with the company's standard one-year warranty; however, specifications designated as "preliminary" are given to describe components only, and Luminent expressly disclaims any and all warranties for said products, including express, implied, and statutory warranties, warranties of merchantability, fitness for a particular purpose, and non-infringement of proprietary rights. Please refer to the company's Terms and Conditions of Sale for further warranty information.

Luminent assumes no liability for applications assistance, customer product design, software performance, or infringement of patents, services, or intellectual property described herein. No license, either express or implied, is granted under any patent right, copyright, or intellectual property right, and Luminent makes no representations or warranties that the product(s) described herein are free from patent, copyright, or intellectual property rights. Products described in this document are NOT intended for use in implantation or other life support applications where malfunction may result in injury or death to persons. Luminent customers using or selling products for use in such applications do so at their own risk and agree to fully defend and indemnify Luminent for any damages resulting from such use or sale.

THE INFORMATION CONTAINED IN THIS DOCUMENT IS PROVIDED ON AN "AS IS" BASIS. Customer agrees that Luminent is not liable for any actual, consequential, exemplary, or other damages arising directly or indirectly from any use of the information contained in this document. Customer must contact Luminent to obtain the latest version of this publication to verify, before placing any order, that the information contained herein is current.

© LuminentOIC, Inc. 2007
All rights reserved