

Product Description

Stanford Microdevices' SHF-0198 series is a high performance AlGaAs/GaAs Heterostructure FET housed in a low-cost stripline-mount ceramic package. HFET technology improves breakdown voltage while minimizing Schottky leakage current for higher power-added efficiency and improved linearity.

Output power at 1dB compression for the SHF-0198 is +27dBm when biased for Class A operation at 9V and 150mA. This HFET is also characterized at 5V for lower voltage applications.

This device can be used in both analog and digital wireless communication infrastructure and subscriber equipment including cellular, PCS, CDPD, wireless data and pagers.

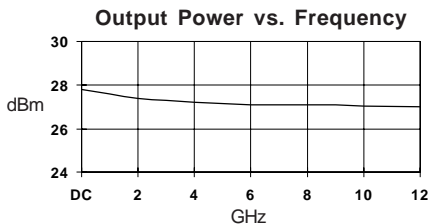

Electrical Specifications at Ta = 25C

Symbol	Parameters: Test Conditions	Units	Min.	Typ.	Max.	
Gp	Power Gain	f = 0.9 GHz	dB	15	17	
		f = 1.9 GHz	dB	12	14	
		f = 2.5 GHz	dB		12	
P1dB	Output Power at 1dB Compression	f = 0.9 GHz	dB	+26.5	+27.5	
		f = 1.9 GHz	dB	+26.3	+27.3	
		f = 2.5 GHz	dB		+27.0	
IP3	Output Third Order Intercept Point	f = 0.9 GHz	dB		+38	
		f = 1.9 GHz	dB		+38	
		f = 2.5 GHz	dB		+37	
NFopt	Noise Figure	f = 0.9 GHz	dB		1.8	
		f = 1.9 GHz	dB		2.2	
		f = 2.5 GHz	dB		2.5	
Idss	Saturated Drain Current: Vds = 3V, Vgs = 0V	mA		300		
Gm	Transconductance: Vds = 3V, Vgs = 0V	mS		175		
Vp	Pinch-off Voltage: Vds = 3V, Ids = 1mA	V		-2.2		
Vbgs	Gate-to-Source Breakdown Voltage	V		-2.0	-1.2	
Vbgd	Gate-to-Drain Breakdown Voltage	V		-2.0	-1.2	

The information provided herein is believed to be reliable at press time. Stanford Microdevices assumes no responsibility for inaccuracies or omissions. Stanford Microdevices assumes no responsibility for the use of this information, and all such information shall be entirely at the user's own risk. Prices and specifications are subject to change without notice. No patent rights or licenses to any of the circuits described herein are implied or granted to any third party. Stanford Microdevices does not authorize or warrant any Stanford Microdevices product for use in life-support devices and/or systems. Copyright 1999 Stanford Microdevices, Inc. All worldwide rights reserved.

SHF-0198

DC-12 GHz, 0.5 Watt AlGaAs/GaAs HFET



Product Features

- Patented AlGaAs/GaAs Heterostructure FET Technology
- +27dBm Output Power at 1dB Compression
- +38 dBm Output IP3
- High Power Added Efficiency - up to 40% at Class A
- 17dB Gain @ 900 MHz, 14dB Gain @ 1.9GHz

Applications

- AMPS, PCS Basestations
- VSAT

SHF-0198 DC-12 GHz 0.5 Watt HFET

Typical Performance at 25° C ($V_{ds} = 9V, I_{ds} = 150mA$)

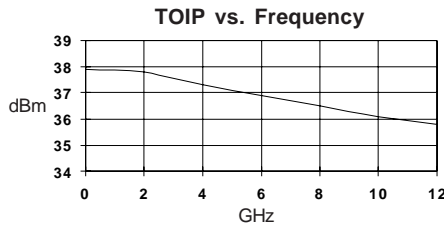
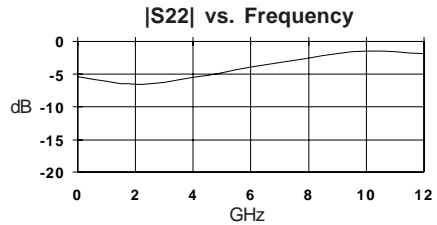
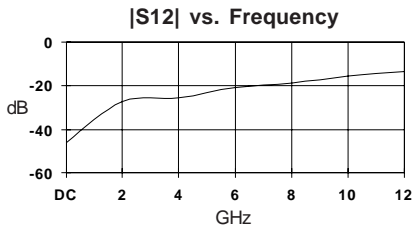
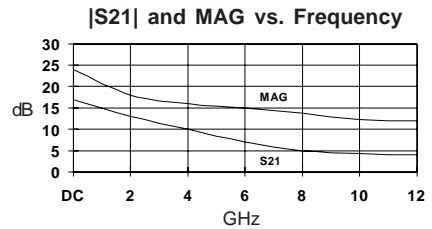
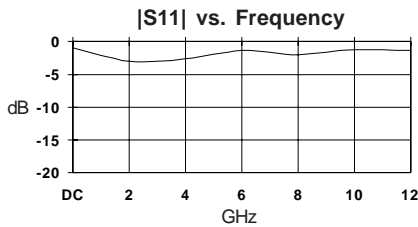

Typical S-Parameters $V_{ds} = 9.0V, I_d = 150mA$

Freq GHz	S11	S11 Ang	S21	S21 Ang	S12	S12 Ang	S22	S22 Ang
.100	0.891	-12	11.82	177	.005	89	.539	-4
.500	0.928	-64	10.84	150	.023	70	.529	-27
1.00	0.888	-97	9.44	122	.037	63	.477	-48
2.00	0.804	-138	7.94	97	.043	47	.468	-74
3.00	0.813	-167	5.69	70	.049	44	.493	-103
4.00	0.804	172	3.98	52	.053	60	.531	-123
5.00	0.846	155	2.76	35	.074	65	.603	-145
6.00	0.914	137	2.02	20	.092	69	.670	-159
7.00	0.917	119	1.66	-1	.137	58	.822	147
8.00	0.926	101	1.45	-4	.115	60	.802	148
9.00	0.967	87	1.37	-11	.205	56	.942	132
10.00	0.970	65	1.33	-34	.167	41	.947	100
11.00	0.937	54	1.38	-31	.186	42	.952	89
12.00	0.906	21	1.33	-38	.207	39	.879	51

(S-Parameters include the effects of two 1.0 mil diameter bond wires, each 30 mils long, connected to the gate and drain pads on the die)

Absolute Maximum Ratings

Parameter	Symbol	Absolute Maximum
Drain to Source Voltage	V_{DS}	+10V
Gate to Source Voltage	V_{GS}	-5V
Drain Current	I_{DS}	IDSS
RF Input Power	P_{IN}	100 mW
Channel Temperature	T_{CH}	175 C
Storage Temperature	T_{STG}	-65 to +175 C
Thermal Resistance, Junction-Ground Lead	R_{IN}	36 degC/W

Part Number Ordering Information

Part Number	Devices Per Tray
SHF-0198	100

Notes:

1. Operation of this device above any one of these parameters may cause permanent damage.
2. Mounting Surface Temperature = 25° C

Outline Drawing

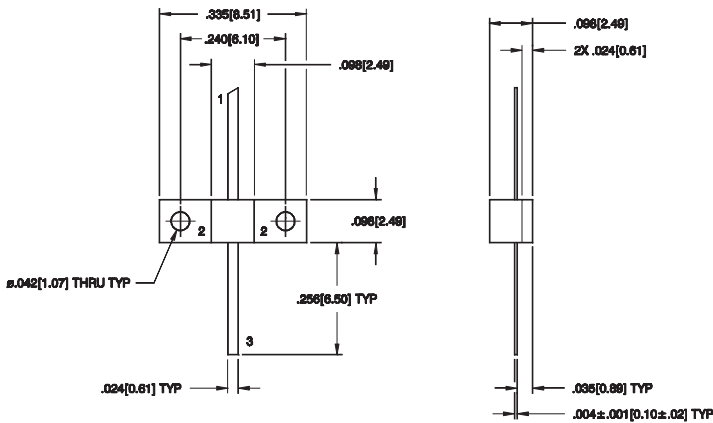

Pin Designation	
1	Gate
2	Source
3	Drain

High Power GaAs FETs