

# WESTCODE

An IXYS Company

Date:- 18 Mar, 2005

Data Sheet Issue:- 1

## Ultra Rapid Semiconductor Protection Fuse European Square Body Fuses













**German Standard DIN 80 Blade Contact  
Voltage Ratings 600V to 690V  
Current Ratings 63A to 1600A  
aR Characteristics  
Sizes 0, 1, 2, 3**













### Key Features:

- ❖ Extremely high interrupting rating fuses for the protection of power semiconductors in accordance with IEC Standard 60269.1 and 4.
- ❖ Exceptionally low  $I^2t$ , power losses
- ❖ Highly reliable low voltage trip indicator system which conforms to UL, IEC, DIN and VDE standards
- ❖ Non Magnetic construction
- ❖ Increased technical performance gives higher ratings and a reduction in volume and weight
- ❖ Microswitch system reference : MS 3V 1-5
- ❖ Fuse holder types : SI DIN80 630A or SI DIN80 1250A









**Main Characteristics:**

Size	Voltage	Ref:		Current rating $I_N$ (A)	Pre-arcing $I^2t @ 1 \text{ ms}$ $I^2t_p$ (kA <sup>2</sup> s)	Total Clearing $I^2t @ U_N$ (kA <sup>2</sup> s)	Watt Losses 0.8I <sub>N</sub> I <sub>N</sub>		Tested Interrupting rating
0	690V	069UR0A0063B		63	0.2	1.1	7.5	14	200kA @690V (IEC) 200kA @700V (USA)
		069UR0A0080B		80	0.33	1.8	9.5	19	
		069UR0A0100B		100	0.47	2.5	13.0	26	
		069UR0A0125B		125	0.85	4.5	15.0	30	
		069UR0A0160B		160	1.6	8.5	18.5	37	
		069UR0A0200B		200	3.	15.5	21.5	43	
		069UR0A0250B		250	5.8	30	25	50	
		069UR0A0315B		315	12	62	22.5	55	
		069UR0A0350B		350	15.5	80	30	60	
	069UR0A0400B		400	23	120	32.5	65		
	690V +6%	069UR0A0450B		450	26	150	44	88	
		069UR0A0500B		500	41	240	44	88	
069UR0A0550B			550	52	300	45	90		











Notes: Minimum operating voltage for integrated trip indicator = 20V  
Microswitch Reference : MS 3V 1-5

Size	Voltage	Ref:		Current rating $I_N$ (A)	Pre-arcing $I^2t @ 1 \text{ ms}$ $I^2t_p$ (kA <sup>2</sup> s)	Total Clearing $I^2t @ U_N$ (kA <sup>2</sup> s)	Watt Losses 0.8I <sub>N</sub> I <sub>N</sub>		Tested Interrupting rating
1	690V	069UR1A0160B		160	1.3	7	27.5	35	200kA @690V (IEC) 200kA @700V (USA)
		069UR1A0200B		200	2.6	13.5	22.5	45	
		069UR1A0315B		250	4.7	25	25.5	52	
		069UR1A0315B		315	7.5	40	32.5	65	
		069UR1A0350B		350	10.5	55	33.5	67	
		069UR1A0400B		400	19	100	34	68	
		069UR1A0450B		450	26.5	140	35	70	
		069UR1A0500B		500	37	195	36	72	
		069UR1A0550B		550	52	280	37.5	75	
		069UR1A0630B		630	75	390	42.5	85	
		069UR1A0700B		700	95	490	42.5	95	

Notes: Minimum operating voltage for integrated trip indicator = 20V  
Microswitch Reference : MS 3V 1-5

Size	Voltage	Ref:		Current rating $I_N$ (A)	Pre-arcing $I^2t @ 1 \text{ ms}$ $I^2t_p(\text{kA}^2\text{s})$	Total Clearing $I^2t @ U_N$ (kA <sup>2</sup> s)	Watt Losses 0.8I <sub>N</sub> I <sub>N</sub>		Tested Interrupting rating
2	690V	069UR2A0400B		400	15	80	32.5	75	200kA @690V (IEC)
		069UR2A0450B		450	20	115	40	80	
		069UR2A0500B		500	28	145	45	90	
		069UR2A0550B		550	37	195	47.5	95	
		069UR2A0630B		630	54	280	52.5	105	
		069UR2A0700B		700	76	400	55	110	
		069UR2A0800B		800	115	600	60	120	
	690V	069UR2A0900B		900	170	905	62.5	125	170kA @700V (USA)
	+6%	069UR2A1000B		1000	240	1250	67.5	135	
	600V	060UR2A1100B	-	1100	270	1450	82.5	165	150kA @600V (IEC)

Notes: Minimum operating voltage for integrated trip indicator = 20V  
Microswitch Reference : MS 3V 1-5

Size	Voltage	Ref:		Current rating $I_N$ (A)	Pre-arcing $I^2t @ 1 \text{ ms}$ $I^2t_p(\text{kA}^2\text{s})$	Total Clearing $I^2t @ U_N$ (kA <sup>2</sup> s)	Watt Losses 0.8I <sub>N</sub> I <sub>N</sub>		Tested Interrupting rating
3	690V	069UR3A0500B		500	19	100	52.5	105	200kA @690V (IEC)
		069UR3A0550B		550	27	140	55	110	
		069UR3A0630B		630	40	210	60	120	
		069UR3A0700B		700	55	300	62.5	125	
		069UR3A0800B		800	95	490	65	130	
		069UR3A0900B		900	135	700	67.5	135	
		069UR3A1000B		1000	170	900	77.5	155	
		069UR3A1100B		1100	240	1260	80	160	
	690V	069UR3A1250B		1250	350	1850	90	180	160kA @700V (USA)
	+6%	069UR3A1400B		1400	480	2500	100	200	
600V	060UR3A1600B	-	1600	555	2900	120	240	200kA @600V (IEC)	

Notes: Minimum operating voltage for integrated trip indicator = 20V  
Microswitch Reference : MS 3V 1-5

**Electrical Characteristics:**

**Times vs current characteristics**

The following curves indicate the pre-arcing time for each rated current as a function of RMS value of pre-arcing current I:

- Tolerances on this current ± 8%
- Beyond 30 sec or 10 sec, small overloads must be eliminated by another device.

Curve CC' represents the maximum times taken by the associated device to clear small overloads; only its horizontal line is represented.

Its oblique line must be plotted according to sketch in top right corner:

- The intersection of the fuse and CC' curves indicates the minimum breaking current I<sub>pm</sub> of the fuse.

**Times vs current characteristics**

**Size 0**

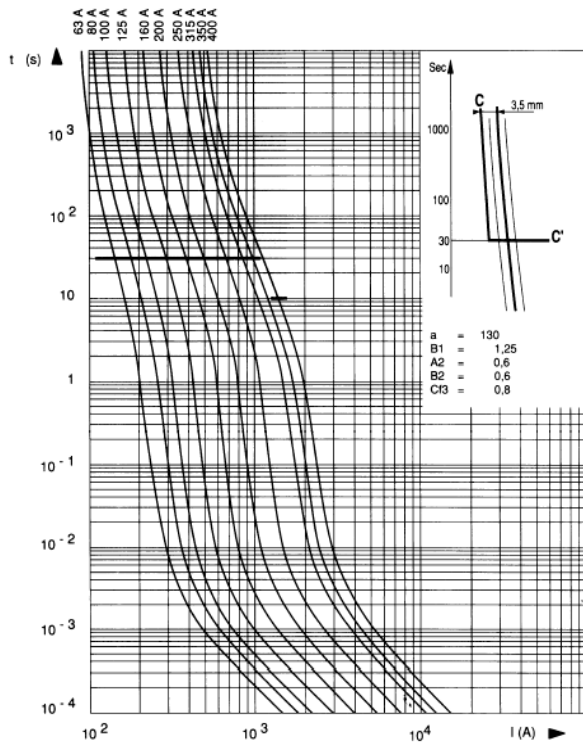

**Size 1**

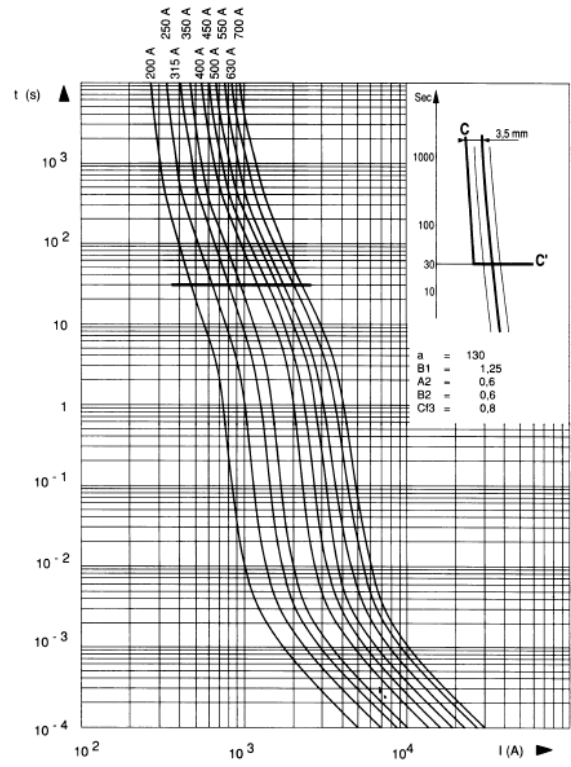

**Size 2**

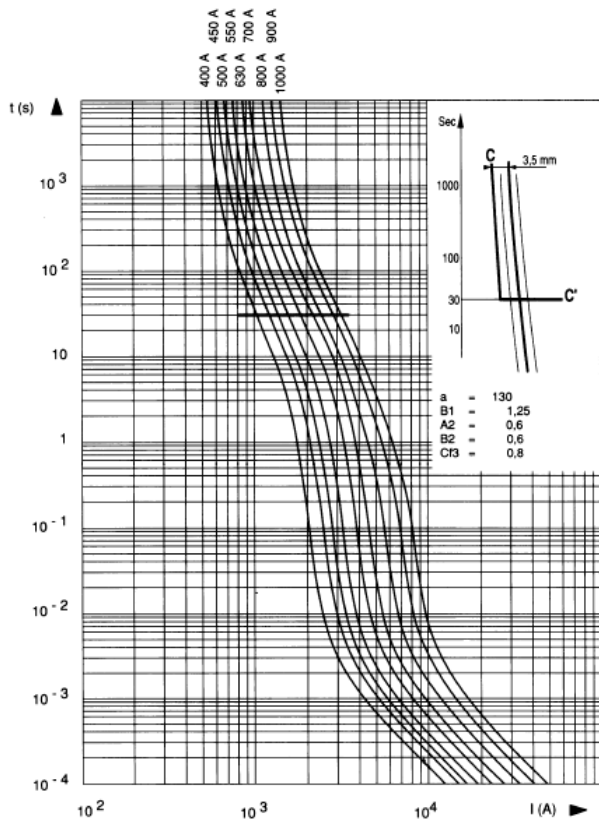

**Size 3**

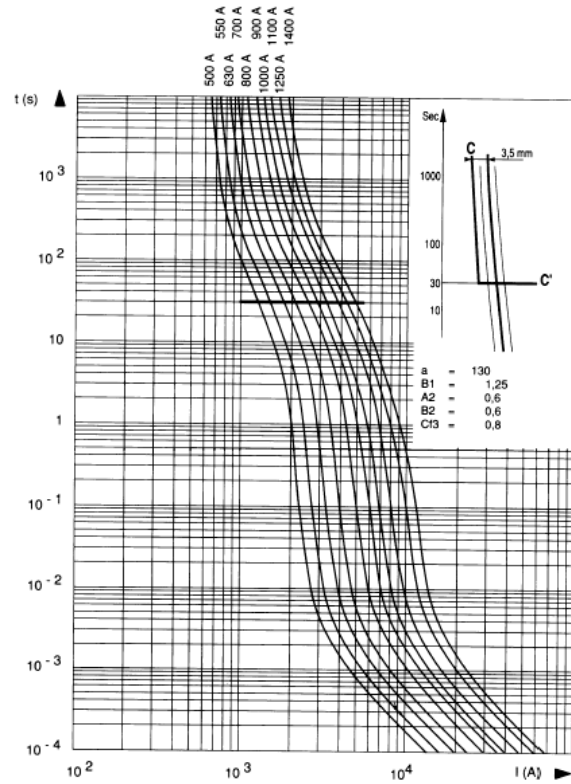

**Total clearing I<sup>2</sup>T:**

The horizontal curves given below indicated the maximum values of total operating I<sup>2</sup>t (I<sup>2</sup>t<sub>t</sub>) as a function of prospective current I<sub>p</sub> @ 660V, cosφ = 0.15. Oblique lines indicate the corresponding total operating time T<sub>t</sub>, with pre-arcing time in brackets.

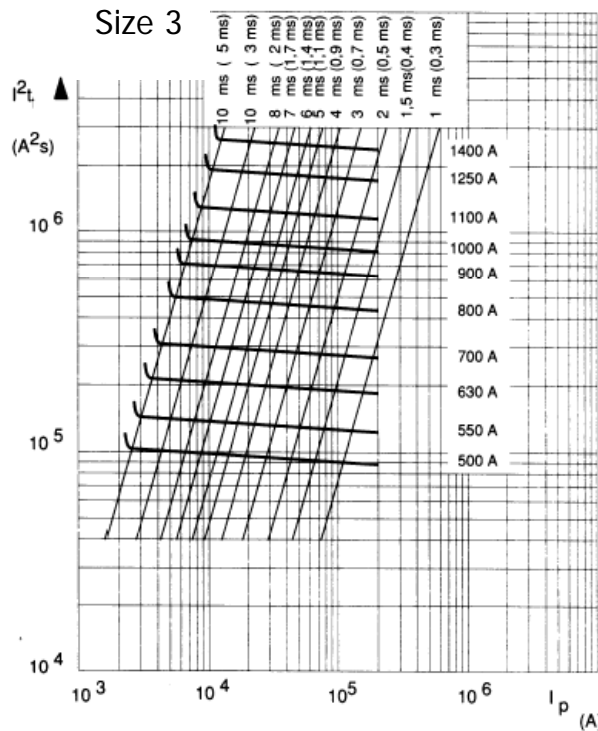
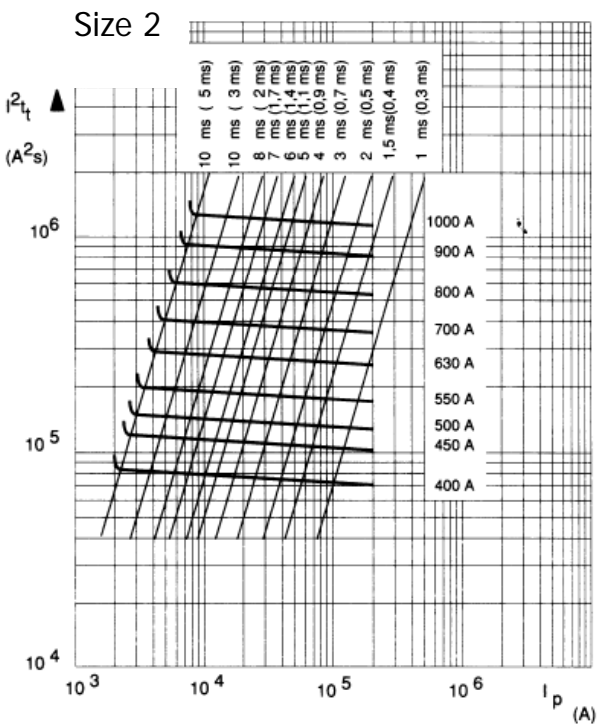
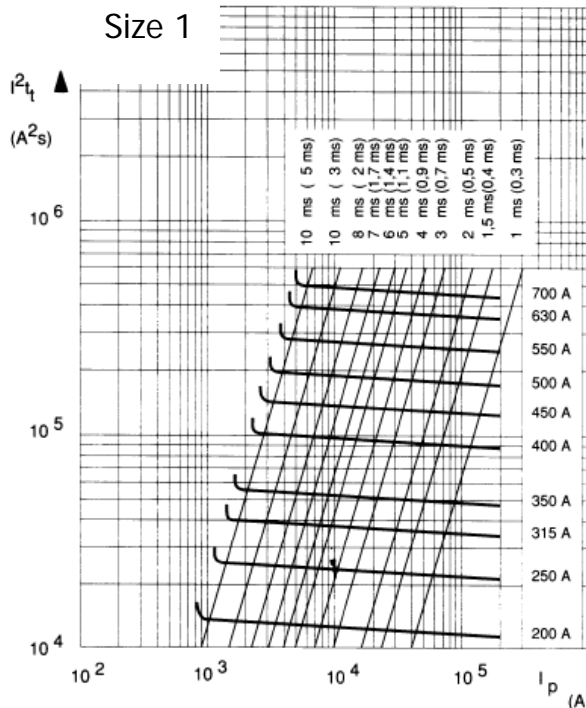
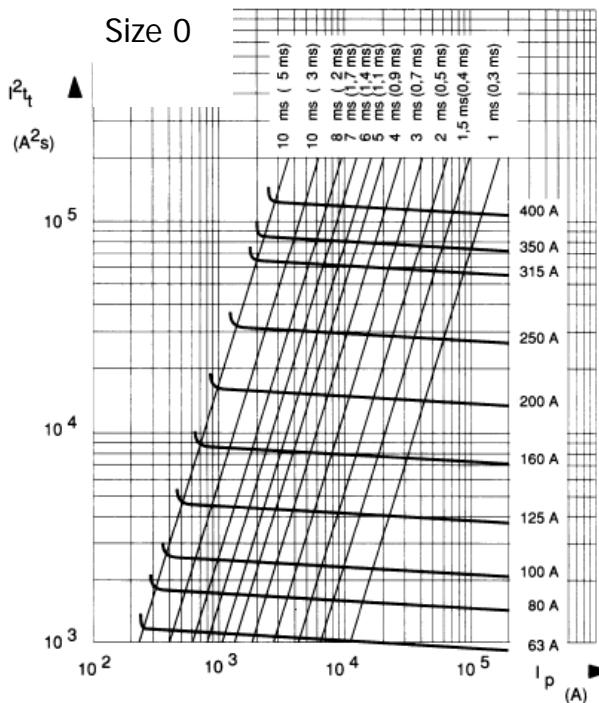

**Cut off Characteristics:**

The curves below indicate, for each rated current, the peak value  $I_c$  that the current may reach as a function of the prospective fault current  $I_p$ .

**Size 0**

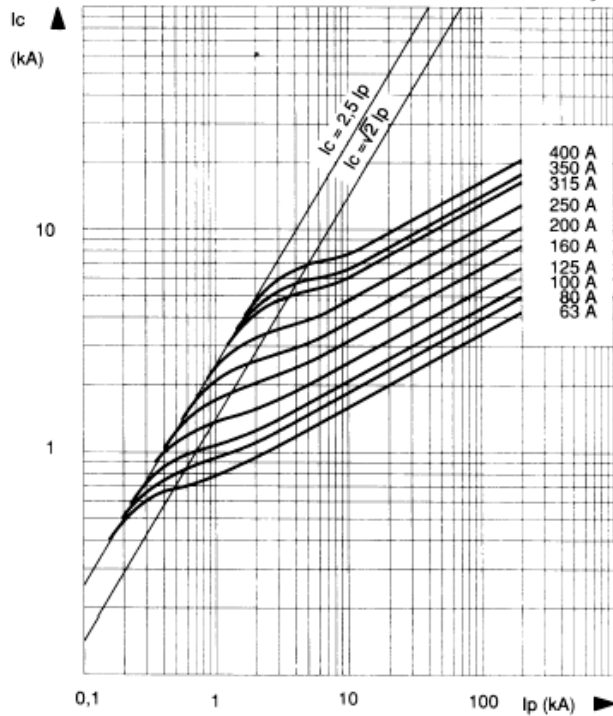

**Size 1**

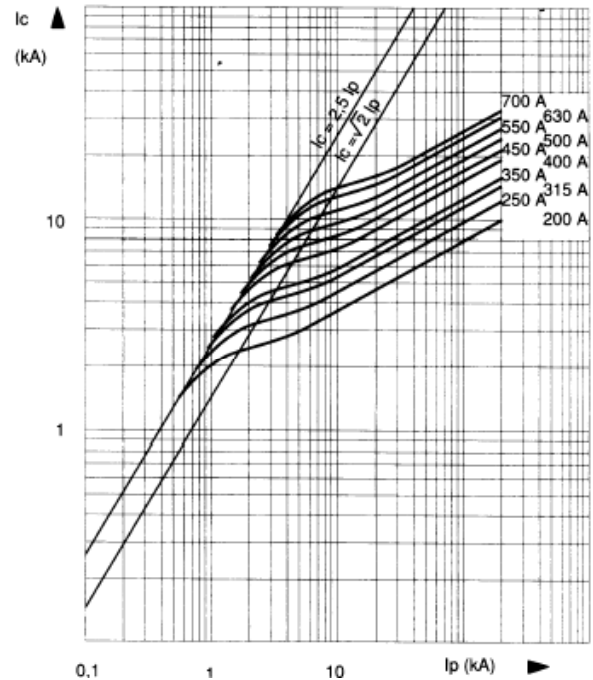

**Size 2**

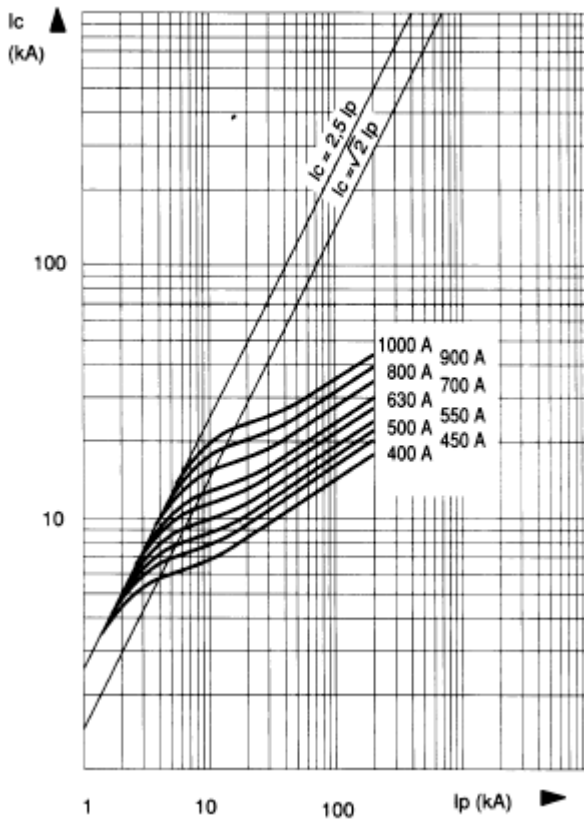

**Size 3**

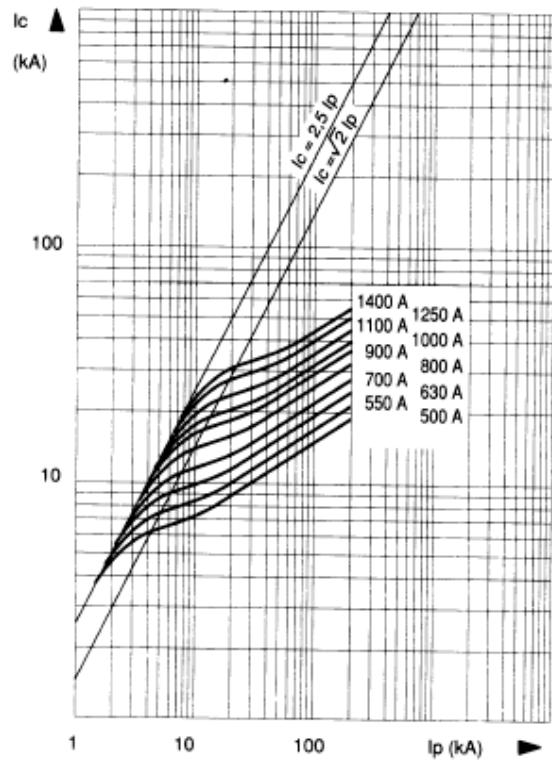

### I<sup>2</sup>t Multiplier Coefficient

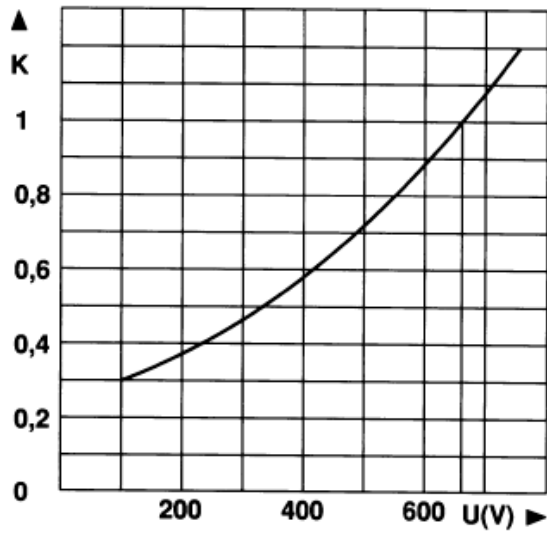

The above Mean curve shows variation of total clearing time ( $I^2t_i$ ) and total operating time  $T_i$  in accordance with working voltage  $U$ .

### Peak Arc Voltage

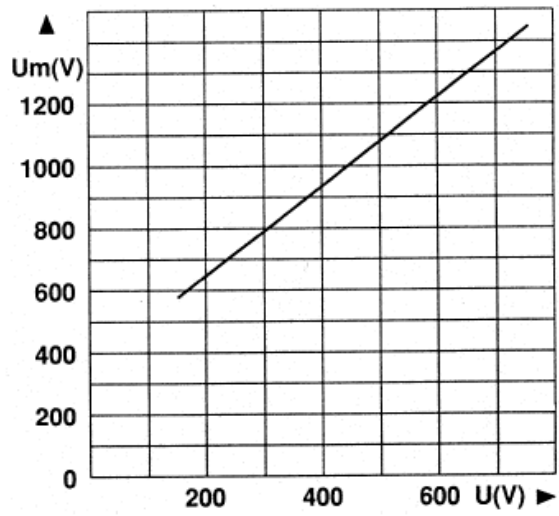

Curve indicating peak arc voltage  $U_m$  which may appear across fuse terminals as a function of working voltage  $U$  @  $\cos \varphi = 0.15$ .

### Dissipated Power

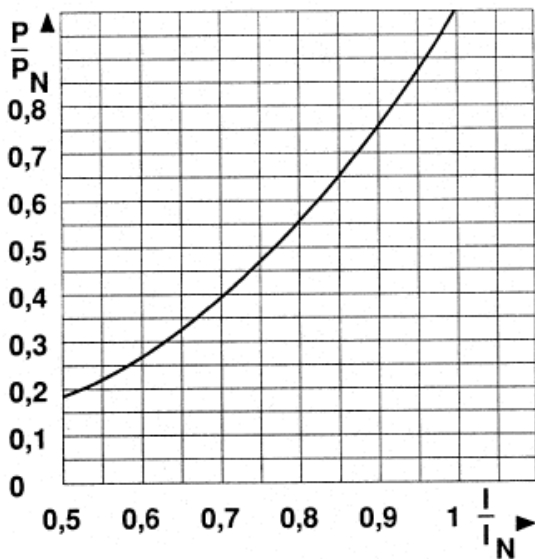

Curve enabling calculation of dissipated power  $P$  by a fuse rated  $I_N$ , as a function of the RMS current  $I$ , in multiples of  $I_N$  in a steady state.

**Outline Drawing & Ordering Information:**

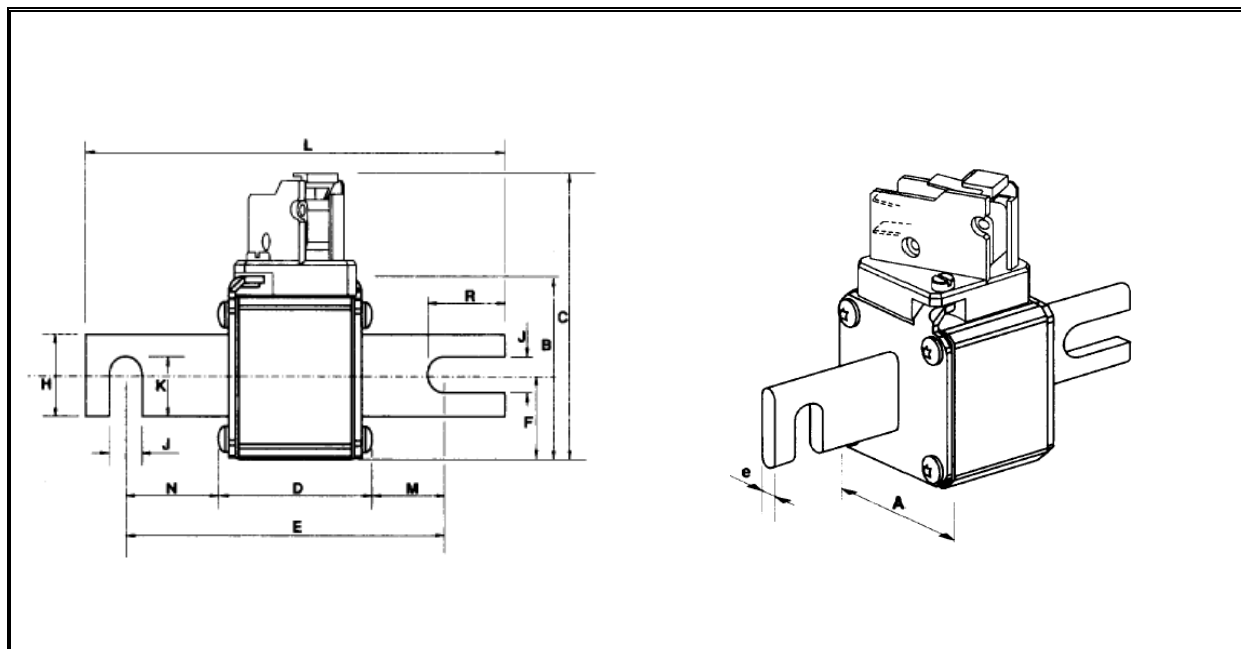

**Dimensions (mm)**

Size	A	B	C	D	E	F	H	J	K	L	M	N	R	e	Weight
0	40	46.5	82	47.5	77	21	25	10.5	17.7	110	11.5	18.5	25.2	6	290g
1	51	56.5	91	47.5	77	25.5	25	10.5	17.7	110	11.5	18.5	25.2	6	430g
2	60	65.5	100	47.5	77	30	32	10.5	21.2	110	11.5	18.5	25.2	6	590g
3	74.5	79.5	114	48.5	77	37.2	40	10.5	25.2	110	11	18	25.2	6	860g

**ORDERING INFORMATION**

(Please quote code as below)

Voltage Rating (V)	Type	Size	Fixing	Current Rating (A)	Indicator
600 – 690	UR	0, 1, 2, 3	A	0063 – 1600	B

Order code: e.g. **069UR1A0350B** = 690V, German Blade Contact, Size 1, DIN80 fixing, 350A, with button indicator

**IXYS Semiconductor GmbH**  
 Edisonstraße 15  
 D-68623 Lampertheim  
 Tel: +49 6206 503-0  
 Fax: +49 6206 503-627  
 E-mail: [marcom@ixys.de](mailto:marcom@ixys.de)



An IXYS Company

**Westcode Semiconductors Ltd**  
 Langley Park Way Langley Park  
 Chippenham Wiltshire SN15 1GE  
 Tel: +44 (0)1249 444524  
 Fax: +44 (0)1249 659448  
 E-mail: [WSL.sales@westcode.com](mailto:WSL.sales@westcode.com)

**IXYS Corporation**  
 3540 Bassett Street  
 Santa Clara CA 95054 USA  
 Tel: +1 (408) 982 0700  
 Fax: +1 (408) 496 0670  
 E-mail: [sales@ixys.com](mailto:sales@ixys.com)

[www.westcode.com](http://www.westcode.com)

[www.ixys.com](http://www.ixys.com)

**Westcode Semiconductors Inc**  
 3270 Cherry Avenue  
 Long Beach CA 90807 USA  
 Tel: +1 (562) 595 6971  
 Fax: +1 (562) 595 8182  
 E-mail: [WSI.sales@westcode.com](mailto:WSI.sales@westcode.com)

The information contained herein is confidential and is protected by Copyright. The information may not be used or disclosed except with the written permission of and in the manner permitted by the proprietors Westcode Semiconductors Ltd.

© Westcode Semiconductors Ltd.

In the interest of product improvement, Westcode reserves the right to change specifications at any time without prior notice.