

TO-92 Plastic Package

**2N4400, 2N4401
2N4402, 2N4403**

*2N4400, 4401 NPN SILICON PLANAR EPITAXIAL TRANSISTORS
2N4402, 4403 PNP SILICON PLANAR EPITAXIAL TRANSISTORS
General Purpose Switching Applications*

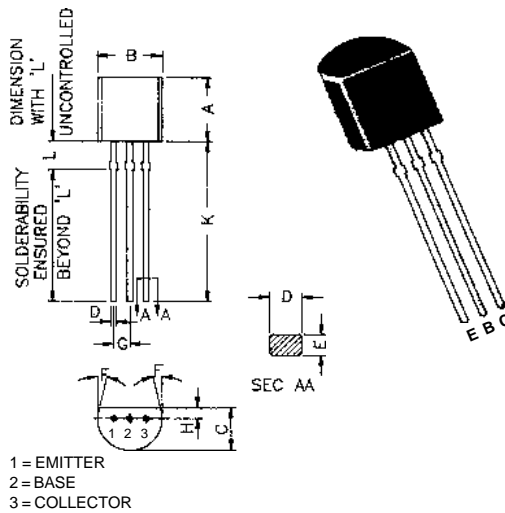

DIM	MIN	MAX
A	4,32	5,33
B	4,45	5,20
C	3,18	4,19
D	0,41	0,55
E	0,35	0,50
F	5 DEG	
G	1,14	1,40
H	1,14	1,53
K	12,70	-
L	1.982	2.082

ALL DIMENSIONS IN M.M.

ABSOLUTE MAXIMM RATINGS

Rating	Symbol	2N4400/01	2N4402/03	Units
Collector-Emitter Voltage	V_{CEO}	40	40	V
Collector-Base Voltage	V_{CBO}	60	40	V
Emitter-Base Voltage	V_{EBO}	6	5	V
Collector Current Continuous	I_C	-	600	- mA
Power Dissipation At $T_a=25\text{ }^\circ\text{C}$	P_D	-	625	- mW
Derate Above $25\text{ }^\circ\text{C}$		-	5.0	- mW/ $^\circ\text{C}$
Power Dissipation At $T_c=25\text{ }^\circ\text{C}$	P_D	-	1.5	- W
Derate Above $25\text{ }^\circ\text{C}$		-	12	- mW/ $^\circ\text{C}$
Operating & Storage Junction Temperature Range	T_j, T_{stg}	-55 to +150		$^\circ\text{C}$

THERMAL RESISTANCE

Junction to Case	$R_{th(f-c)}$	-	83.3	- $^\circ\text{C}/\text{W}$
Junction to Ambient	$R_{th(f-a)}$	-	200	- $^\circ\text{C}/\text{W}$

ELECTRICAL CHARACTERISTICS ($T_a = 25\text{ }^\circ\text{C}$ unless otherwise specified)

2N4400, 2N4401
2N4402, 2N4403

Characteristic	Symbol	2N4400/01	2N4402/03	Unit
<i>Collector Emitter Voltage</i>				
$I_C=1mA, I_B=0$	BV_{CEO}^*	>40	>40	V
<i>Collector Base Voltage</i>				
$I_C=100\mu A, I_E=0$	BV_{CBO}	>60	>40	V
<i>Emitter Base Voltage</i>				
$I_E=100\mu A, I_C=0$	BV_{EBO}	>6	>5	V
<i>Base Cutoff Current</i>				
$V_{CE}=35V, V_{BE}=0.4V$	I_{BEV}	<0.1	<0.1	μA
<i>Collector Cutoff Current</i>				
$V_{CE}=35V, V_{BE}=0.4V$	I_{CEX}	<0.1	<0.1	μA
<i>Collector-Emitter Saturation Voltage</i>				
$I_C=150mA, I_B=15mA$	$V_{CE(sat)}^*$	<0.4	<0.4	V
$I_C=500mA, I_B=50mA$		<0.75	<0.75	V
<i>Base-Emitter Saturation Voltage</i>				
$I_C=150mA, I_B=15mA$	$V_{BE(sat)}^*$	0.75 to 0.95	0.75 to 0.95	V
$I_C=500mA, I_B=50mA$		<1.2	<1.3	V

Characteristic	Symbol	2N4400	2N4401	2N4402	2N4403	Unit
<i>D C Current Gain</i>						
$I_C=0.1mA, V_{CE}=1V$	h_{FE}	-	>20	-	>30	
$I_C=1mA, V_{CE}=1V$		>20	>40	>30	>60	
$I_C=10mA, V_{CE}=1V$		>40	>80	>50	>100	
$I_C=150mA, V_{CE}=1V^*$		50-150	100-300	-	-	
$I_C=150mA, V_{CE}=2V^*$		-	-	50-150	100-300	
$I_C=500mA, V_{CE}=2V^*$		>20	>40	>20	>20	
DYNAMIC CHARACTERISTICS						
<i>Small Signal Current Gain</i>						
$I_C=1mA, V_{CE}=10V, f=1KHz$	h_{fe}	20-250	40-500	30-250	60-500	
<i>Input Impedance</i>						
$I_C=1mA, V_{CE}=10V, f=1KHz$	h_{ie}	0.5-7.5	1.0-15	0.75-7.5	1.5-15	$K\Omega$

2N4400, 2N4401
2N4402, 2N4403

Characteristic	Symbol	2N4400	2N4401	2N4402	2N4403	Unit
Voltage Feedback Ratio $I_C=1mA, V_{CE}=10V, f=1KHz$	h_{re} ALL			0.1-8.0		$\times 10^{-4}$
Output Admittance $I_C=1mA, V_{CE}=10V, f=1KHz$	h_{oe}	1.0-30	1.0-30	1.0-100	1.0-100	μS
Collector-Base Capacitance $V_{CB}=5V, I_E=0, f=100KHz$ $V_{CB}=10V, I_E=0, f=140KHz$	C_{cb}	<6.5	<6.5	-	-	pF
Emitter-Base Capacitance $V_{EB}=0.5V, I_C=0, f=100KHz$ $V_{EB}=0.5V, I_C=0, f=140KHz$	C_{eb}	<30	<30	-	-	pF
Transition Frequency $I_C=20mA, V_{CE}=10V$ $f=100MHz$	f_T	>200	>250	>150	>200	MHz

SWITCHING CHARACTERISTICS

$V_{CC}=30V, V_{EB}=2V,$ $I_C=150mA, I_{B1}=15mA$						
Delay time	t_d ALL			<15		ns
Rise time	t_r ALL			<20		ns
$V_{CC}=30V, I_C=150mA,$ $I_{B1}=I_{B2}=15mA$						
Storage time	t_s ALL			<225		ns
Fall time	t_f ALL			<30		ns

*Pulse Test : Pluse width $\leq 300\mu s$, duty $\leq 2.0\%$.

DC Current Gain

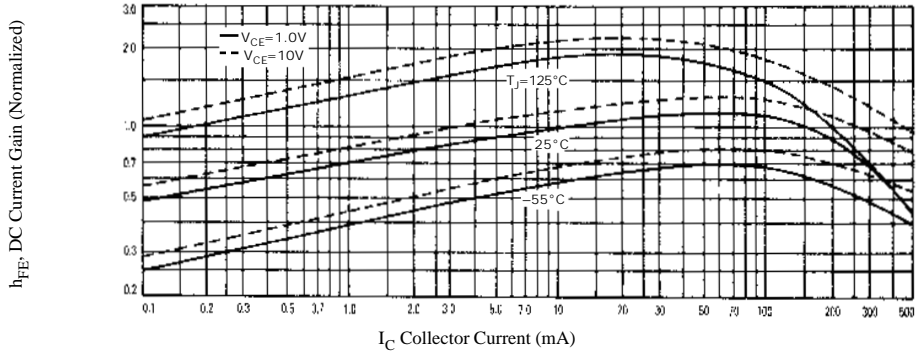

DC Current Gain

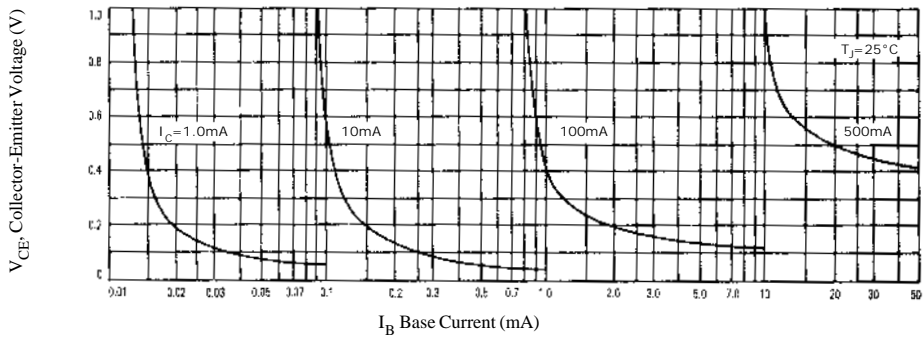

On Voltages

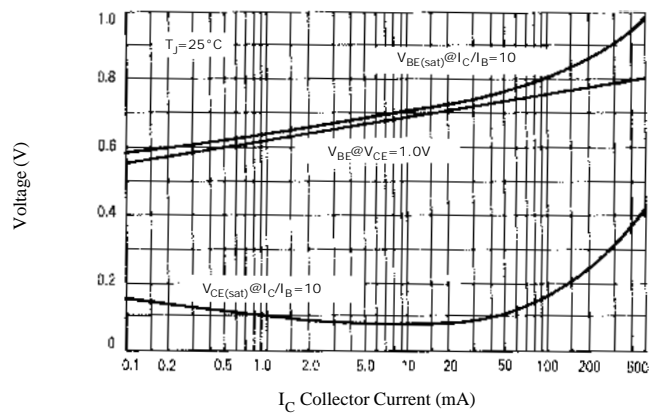

DC Current Gain

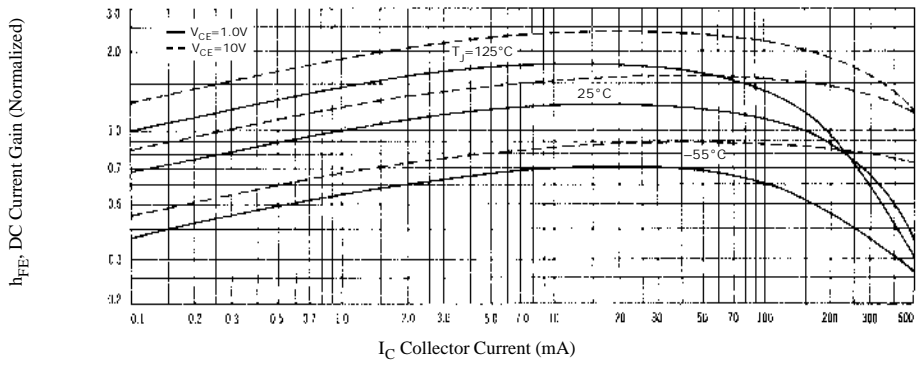

Collector Saturation Region

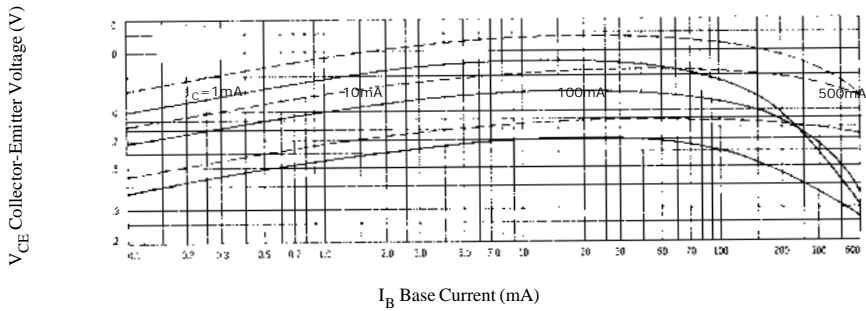

On Voltages

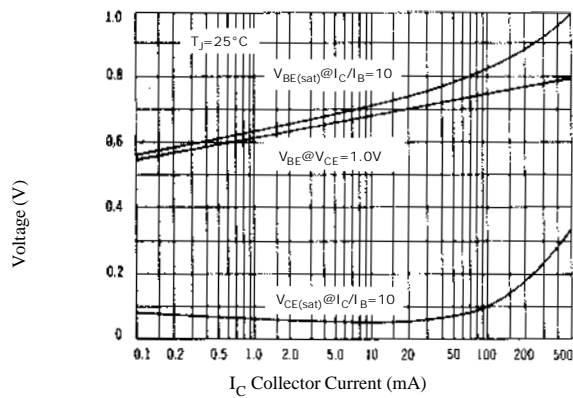

Notes

Disclaimer

The product information and the selection guides facilitate selection of the CDIL's Discrete Semiconductor Device(s) best suited for application in your product(s) as per your requirement. It is recommended that you completely review our Data Sheet(s) so as to confirm that the Device(s) meet functionality parameters for your application. The information furnished on the CDIL Web Site/ CD is believed to be accurate and reliable. CDIL however, does not assume responsibility for inaccuracies or incomplete information. Furthermore, CDIL does not assume liability whatsoever, arising out of the application or use of any CDIL product; neither does it convey any license under its patent rights nor rights of others. These products are not designed for use in life saving/support appliances or systems. CDIL customers selling these products (either as individual Discrete Semiconductor Devices or incorporated in their end products), in any life saving/support appliances or systems or applications do so at their own risk and CDIL will not be responsible for any damages resulting from such sale(s).

CDIL strives for continuous improvement and reserves the right to change the specifications of its products without prior notice.



CDIL is a registered Trademark of
Continental Device India Limited

C-120 Naraina Industrial Area, New Delhi 110 028, India.
Telephone + 91-11-2579 6150, 5141 1112 Fax + 91-11-2579 5290, 5141 1119
email@cdil.com www.cdilsemi.com