

SANYO

No. 3529

VPA15**Video Pack, Video Output Amplifier
for High-resolution CRT Displays****OVERVIEW**

The VPA15 is a composite, single-channel, video output amplifier IC for high-resolution monochrome or RGB CRT displays. It is fabricated using hybrid technology and incorporates high-precision FBET and LSBT transistors to provide high output voltages over a wide bandwidth with minimal external components. The single-in-line, metal package reduces EMI and simplifies circuit board design.

The VPA15 is ideally suited to high-resolution monitors which use a 70 to 90 kHz line frequency. Applications include high-end desk-top publishing monitors, medical monitors and other high-resolution graphics applications. The VPA18 three-channel amplifier is recommended for RGB applications.

The VPA15 operates from an 90 V supply (typ) and is available in 9-pin SIPs.

FEATURES

- Up to 40 V_{pp} output
- High-precision FBET and LSBT transistors
- 150 MHz bandwidth
- Low external component count
- Metal case reduces EMI
- Single-in-line package simplifies circuit board design
- Up to 90 V supply and 15 V bias
- 9-pin SIP

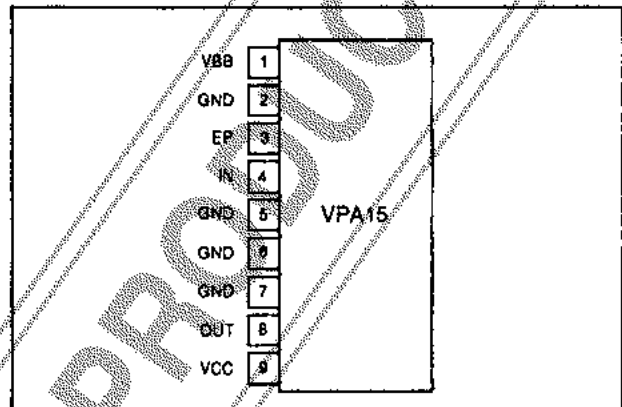
PINOUT**PACKAGE DIMENSIONS**

Unit: mm

2060

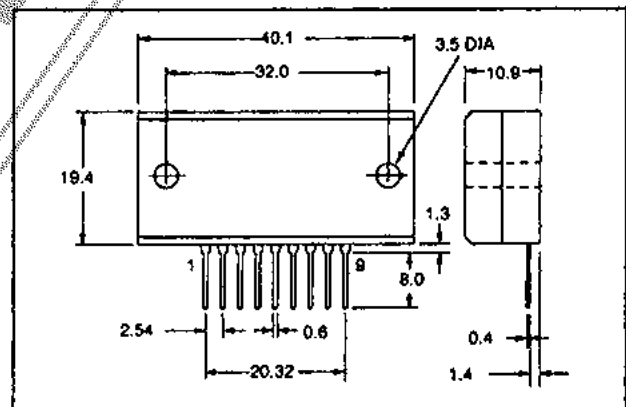

Specifications and information herein are subject to change without notice.

SANYO Electric Co., Ltd. Semiconductor Division
Natsume Bldg., 18-6, 2-chome, Yushima, Bunkyo-ku, Tokyo 113, Japan

INTERNAL CIRCUIT

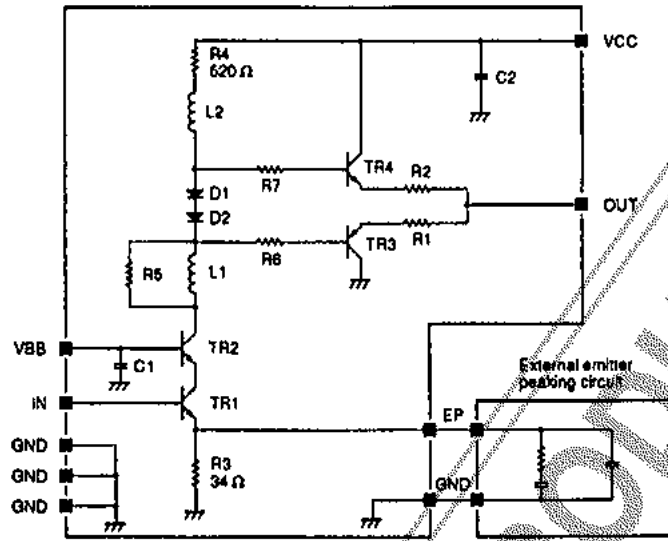

PIN DESCRIPTION

Number	Name	Description
1	VBB	Bias voltage
2, 5, 6, 7	GND	Ground
3	EP	External peaking input
4	IN	Input
8	OUT	Output
9	VCC	Supply voltage

SPECIFICATIONS

Absolute Maximum Ratings

Parameter	Symbol	Rating	Unit
Supply voltage	V _{CC} max	90	V
Bias voltage	V _{BB} max	15	V
Power dissipation	P _D	3.5 (T _a = 25 deg. C)	W
		20 (T _c = 25 deg. C)	
Junction temperature	T _j	150	deg. C
Operating temperature	T _{opp}	85	deg. C
Storage temperature range	T _{stg}	-20 to 110	deg. C

VPA15

Recommended Operating Conditions

$T_a = 25 \text{ deg. C}$

Parameter	Symbol	Condition	Rating			Unit
			min	typ	max	
Supply voltage	V_{CC}	$V_{out} = 30 V_{p-p}$, $V_{in}(DC) = 2.8 \text{ V}$	-	70	-	V
Bias voltage	V_{BB}		-	10	-	V
Supply voltage	V_{CC}	$V_{out} = 40 V_{p-p}$, $V_{in}(DC) = 3.1 \text{ V}$	-	80	-	V
Bias voltage	V_{BB}		-	10	-	V

Electrical Characteristics

$T_a = 25 \text{ deg. C}$

Parameter	Symbol	Condition	Rating			Unit
			min	typ	max	
Frequency bandwidth	f_c (-3 dB)	$V_{out} = 30 V_{p-p}$, $V_{CC} = 70 \text{ V}$, $V_{BB} = 10 \text{ V}$, $V_{in}(DC) = 2.8 \text{ V}$	-	150	-	MHz
		$V_{out} = 40 V_{p-p}$, $V_{CC} = 80 \text{ V}$, $V_{BB} = 10 \text{ V}$, $V_{in}(DC) = 3.1 \text{ V}$	-	150	-	
Voltage gain	G_v		12	14	16	
Current consumption	I_{CC}	$f = 10 \text{ MHz}$, $V_{CC} = 70 \text{ V}$, $V_{BB} = 10 \text{ V}$	-	72	-	mA
		$f = 150 \text{ MHz}$, $V_{CC} = 70 \text{ V}$, $V_{BB} = 10 \text{ V}$	-	102	-	
		$f = 10 \text{ MHz}$, $V_{CC} = 80 \text{ V}$, $V_{BB} = 10 \text{ V}$	-	84	-	
		$f = 150 \text{ MHz}$, $V_{CC} = 80 \text{ V}$, $V_{BB} = 10 \text{ V}$	-	128	-	

Measurement Circuit

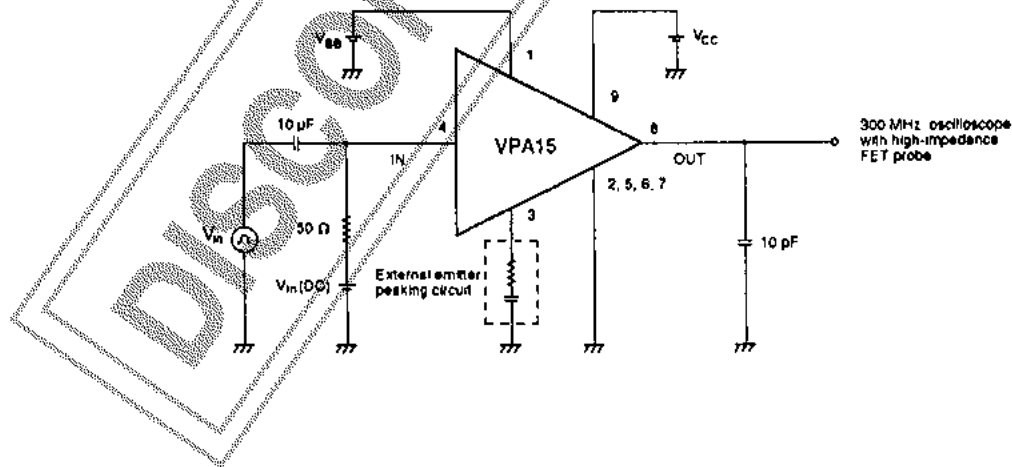

Typical Performance Characteristics

Output voltage vs. frequency

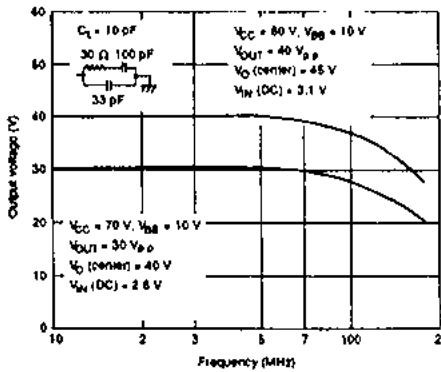

Supply current vs. Input voltage

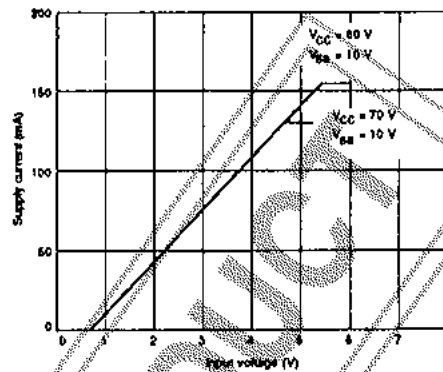

Supply current vs. frequency

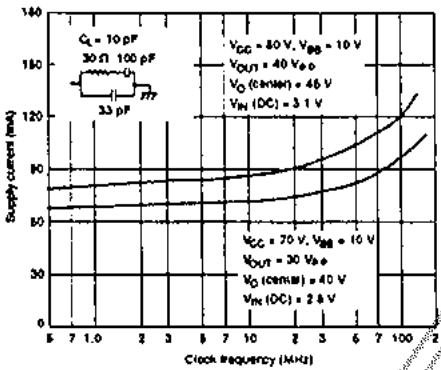

Power dissipation vs. ambient temperature

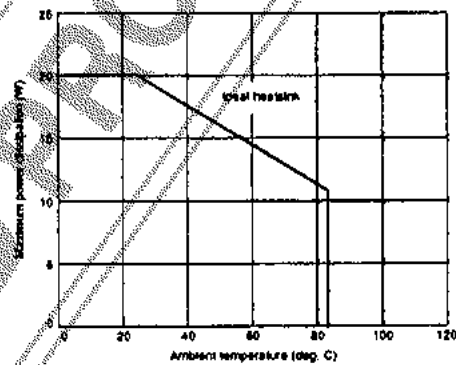

Output voltage vs. DC Input voltage

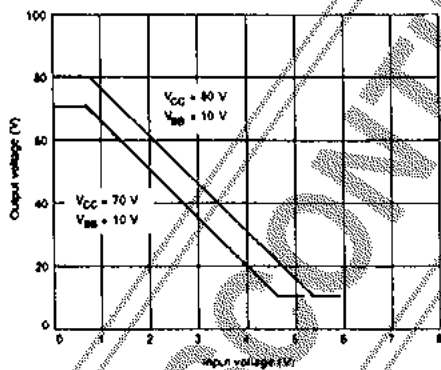

HEATSINK DESIGN

The transistor junction temperature should be kept below 150 deg. C. To achieve this, heatsinks should be designed to keep the case temperature below 90 deg. C. Note that the quantity of heat dissipated is proportional to the operating frequency. Thermal calculations should be carried out using the thermal dissipation specified at the maximum operating frequency of 150 MHz. Transistor TR2 generates the most heat—24% of the total dissipation—and is used in the following heatsink design calculations.

The transistor junction temperature, T_j , is calculated using the following equation.

$$T_j = (\theta_{j-c} \times P_c) + \Delta T_c + T_a \text{ (deg. C)}$$

where the symbols are defined as follows.

- θ_{j-c} Junction-to-case thermal resistance
- P_c Collector loss of the transistor
- ΔT_c Case temperature rise
- T_a Ambient temperature
- θ_h Heatsink thermal resistance

The junction-to-case thermal resistance, θ_{j-c} , is 30 deg. C/W, for transistor TR1 and 20 deg. C/W for transistors TR2 to TR4.

The collector loss, P_c , of each transistor is calculated using the following equation.

$$P_c = P_D \times \text{heat dissipation ratio}$$

The heat dissipation ratio for TR2 is 0.24.

The case temperature rise is calculated using the following equation.

$$\Delta T_c = P_D \times \theta_b$$

Power dissipation vs. signal frequency is shown in figure 1, and collector loss vs. frequency, in figure 2.

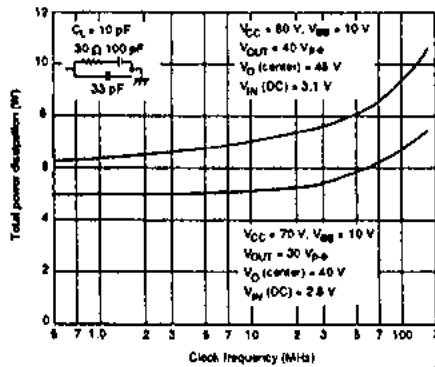

Figure 1. Power dissipation vs. signal frequency

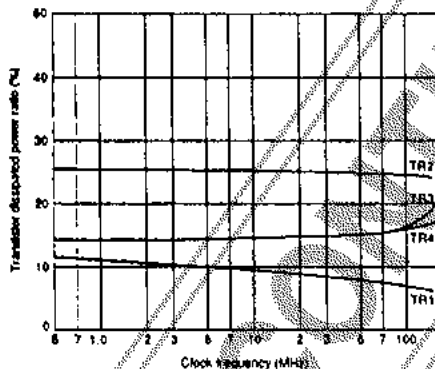

Figure 2. Collector loss vs. signal frequency

Sample Calculations

Example 1

This calculation uses the following conditions.

- Signal frequency = 150 MHz
- $V_{CC} = 80 \text{ V}$
- $V_{BB} = 10 \text{ V}$
- $V_{out} = 40 \text{ V}_{p-p}$
- $C_L = 10 \text{ pF}$
- $T_a = 60 \text{ deg. C}$

TR2 collector loss

$$\begin{aligned} P_c &= P_D \times \text{heat dissipation ratio} \\ &= 10.2 \times 0.24 \\ &= 2.45 \text{ W} \end{aligned}$$

P_D is read from figure 1.

Case temperature rise

$$\begin{aligned} T_j &= (\theta_{j-c} \times P_c) + \Delta T_c + T_a \\ \Delta T_c &= T_j - T_a - (\theta_{j-c} \times P_c) \\ &= 150 - 60 - (20 \times 2.45) \\ &= 41 \text{ deg. C} \end{aligned}$$

Heatsink thermal resistance

$$\begin{aligned} \Delta T_c &= P_D \times \theta_b \\ \theta_b &= \Delta T_c / P_D \\ &= 41 / 10.2 \\ &= 4.0 \text{ deg. C/W} \end{aligned}$$

Heatsink thermal resistance should be less than 4.0 deg. C/W.

Example 2

The conditions are identical to those in example 1 except for the following.

- $V_{CC} = 70 \text{ V}$
- $V_{out} = 30 \text{ V}_{p-p}$

The thermal resistance of the heatsink, θ_h , is calculated to be 7.7 deg. C/W by using the steps given in example 1. However, the heatsink should have a thermal resistance less than this value.

PRECAUTIONS

- Pins should not be short-circuited while power is applied.
- Correct heatsinking should be used to keep the case temperature below 90 deg. C.
- Note that the case is connected to ground.
- The recommended mounting torque is 4 to 6 kg/cm.

Information (including circuit diagrams and circuit parameters) herein is for example only; it is not guaranteed for volume production. SANYO believes information herein is accurate and reliable, but no guarantees are made or implied regarding its use or any infringements of intellectual property rights or other rights of third parties.