

HDSP-315x/316x/515x/516x Series

10 mm and 13 mm Slim Font Seven Segment Displays

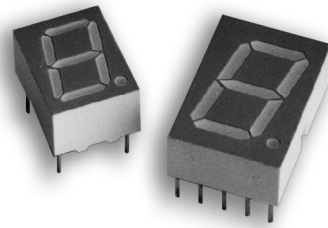

Data Sheet



Description

The HDSP-31xx-51xx Series of displays incorporates a new slim font character design. This slim font features narrow width, specially mitered segments to give a fuller appearance to the illuminated character. Faces of these displays are painted a neutral gray for enhanced on/off contrast.

All devices are available in either common anode or common cathode configuration with right hand decimal point. Low current versions are available in either AlGaAs red or HER.

Features

- Excellent appearance
- Slim font design
- Mitered corners, evenly illuminated segments
- Gray face for optimum on/off contrast
- Choice of colors: DH AlGaAs Red, High Efficiency Red (HER), Yellow, and Green
- Low current available, AlGaAs Red and HER Choice of character size: 10 mm and 13 mm
- $\pm 50^\circ$ viewing angle
- Characterized for luminous intensity

Devices

AlGaAs Red Low Current HDSP-	HER Std. Current HDSP-	HER Low Current HDSP-	Yellow Std. Current HDSP-	Green Std. Current HDSP-	Description	Package Drawing
315H	315E	315L	315Y	315G	Common Anode, 10 mm Display	A
316H	316E	316L	316Y	316G	Common Cathode, 10 mm Display	B
515H	515E	515L	515Y	515G	Common Anode, 13 mm Display	A
516H	516E	516L	516Y	516G	Common Cathode, 13 mm Display	B

Part Numbering System

5082 -X X X X-X X X X X

HDSP-X X X X-X X X X X

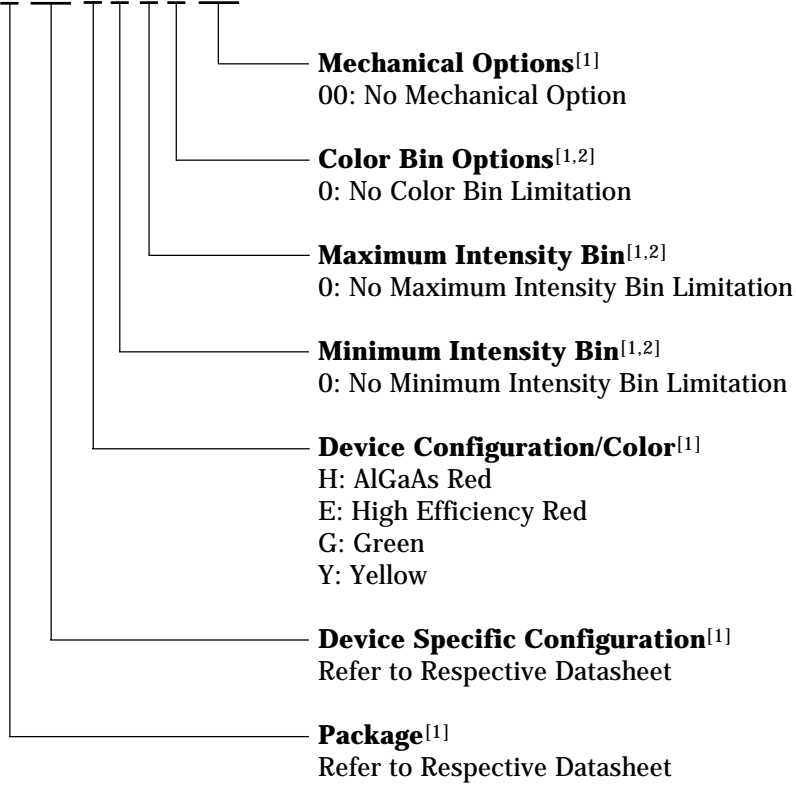

Notes:

1. For codes not listed in the figure above, please refer to the respective datasheet or contact your nearest Avago representative for details.
2. Bin options refer to shippable bins for a part number. Color and Intensity Bins are typically restricted to 1 bin per tube (exceptions may apply). Please refer to respective datasheet for specific bin limit information.

HDSP-315x/316x Series

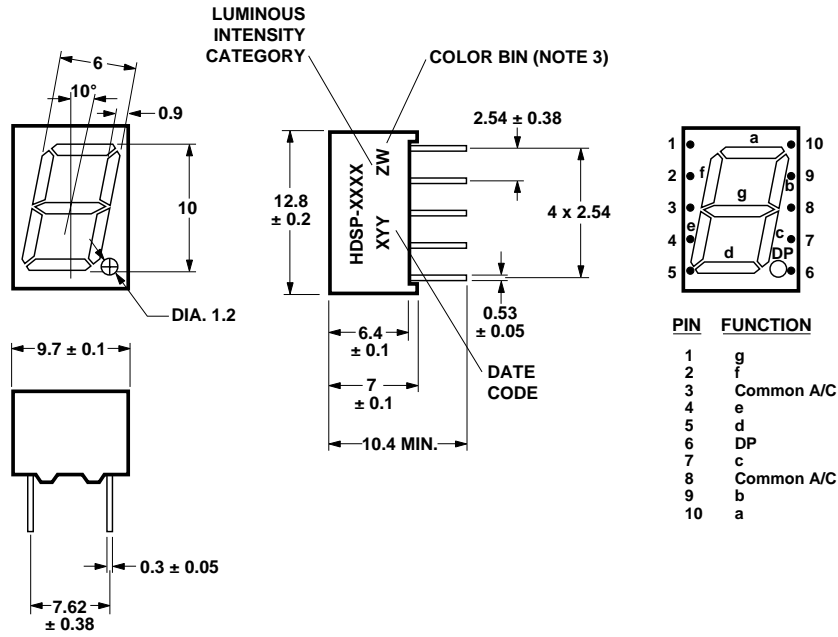

HDSP-515x/516x Series

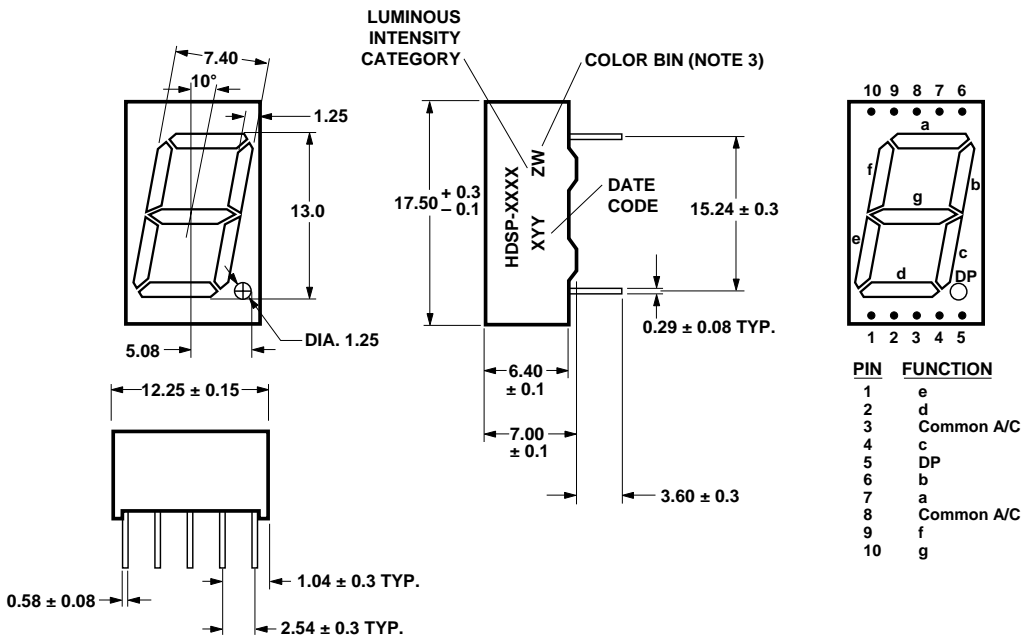

NOTES: 1. PACKAGE DIMENSIONS IN MILLIMETERS.
 2. UNTOLERANCED DIMENSIONS ARE FOR REFERENCE ONLY.
 3. FOR YELLOW AND GREEN DEVICES ONLY.

Absolute Maximum Ratings

Description	AlGaAs Red Low Current	HER	HER Low Current	Yellow	Green	Units
Average Power per Segment or DP	37	105	52	80	105	mW
Peak Forward Current per Segment or DP	45	90 ^[2]	45	60 ^[5]	90 ^[7]	mA
DC Forward Current per Segment or DP	15 ^[1]	30 ^[3]	15 ^[4]	20 ^[6]	30 ^[8]	mA
Operating Temperature Range	-20 to 100	-40 to +100				°C
Storage Temperature Range	-40 to +100					°C
Reverse Voltage per Segment or DP	3.0					V
Wavesoldering Temperature for 3 seconds 1.59 mm. below body	250					°C

Notes:

1. Derate above 91°C at 0.53 mA/°C.
2. See Figure 4 to establish pulsed conditions.
3. Derate above 53°C at 0.45 mA/°C.
4. Derate above 80°C at 0.38 mA/°C.
5. See Figure 5 to establish pulsed conditions.
6. Derate above 81°C at 0.52 mA/°C.
7. See Figure 6 to establish pulsed ocnditions.
8. Derate above 39°C at 0.37 mA/°C.

Electrical/Optical Characteristics at $T_A = 25^\circ\text{C}$

AlGaAs Red Low Current

Device Series HDSP-	Parameter	Symbol	Min.	Typ.	Max.	Units	Test Conditions
315/316H 515/516H	Luminous Intensity/Segment ^[1,2] (Digit Average)	I_V	180	650		μcd	$I_F = 1 \text{ mA}$
	Forward Voltage/Segment or DP	V_F		1.8	2.2	V	$I_F = 1 \text{ mA}$
	Peak Wavelength	λ_{PEAK}		645		nm	
	Dominant Wavelength ^[3]	λ_d		637		nm	
	Reverse Voltage/Segment or DP ^[4]	V_R	3	15		V	$I_R = 100 \mu\text{A}$
	Thermal Resistance LED Junction-to-Pin	$R\theta_{\text{J-PIN}}$		255		$^\circ\text{C/W/Seg}$	

HER

Device Series HDSP-	Parameter	Symbol	Min.	Typ.	Max.	Units	Test Conditions
315/316E 515/516E	Luminous Intensity/Segment ^[1,2] (Digit Average)	I_V	450	2600		μcd	$I_F = 10 \text{ mA}$
	Forward Voltage/Segment or DP	V_F		1.9	2.5	V	$I_F = 10 \text{ mA}$
	Peak Wavelength	λ_{PEAK}		635		nm	
	Dominant Wavelength ^[3]	λ_d		626		nm	
	Reverse Voltage/Segment or DP ^[4]	V_R	3	30		V	$I_R = 100 \mu\text{A}$
	Thermal Resistance LED Junction-to-Pin	$R\theta_{\text{J-PIN}}$		200		$^\circ\text{C/W/Seg}$	

HER Low Current

Device Series HDSP-	Parameter	Symbol	Min.	Typ.	Max.	Units	Test Conditions
315/316L 515/516L	Luminous Intensity/Segment ^[1,2] (Digit Average)	I_V	180	370		μcd	$I_F = 2 \text{ mA}$
	Forward Voltage/Segment or DP	V_F		2.1	2.5	V	$I_F = 2 \text{ mA}$
	Peak Wavelength	λ_{PEAK}		635		nm	
	Dominant Wavelength ^[3]	λ_d		626		nm	
	Reverse Voltage/Segment or DP ^[4]	V_R	3	30		V	$I_R = 100 \mu\text{A}$
	Thermal Resistance LED Junction-to-Pin	$R\theta_{\text{J-PIN}}$		200		$^\circ\text{C/W/Seg}$	

Yellow

Device Series HDSP-	Parameter	Symbol	Min.	Typ.	Max.	Units	Test Conditions
315/316Y 515/516Y	Luminous Intensity/Segment ^[1,2] (Digit Average)	I_V	450	1800		μcd	$I_F = 10 \text{ mA}$
	Forward Voltage/Segment or DP	V_F		2.0	2.5	V	$I_F = 10 \text{ mA}$
	Peak Wavelength	λ_{PEAK}		583		nm	
	Dominant Wavelength ^[3]	λ_d		586		nm	
	Reverse Voltage/Segment or DP ^[4]	V_R	3	50		V	$I_R = 100 \mu\text{A}$
	Thermal Resistance LED Junction-to-Pin	$R_{\theta\text{J-PIN}}$		200		$^{\circ}\text{C/W/Seg}$	

Green

Device Series HDSP-	Parameter	Symbol	Min.	Typ.	Max.	Units	Test Conditions
315/316E 515/516E	Luminous Intensity/Segment ^[1,2] (Digit Average)	I_V	450	5000		μcd	$I_F = 10 \text{ mA}$
	Forward Voltage/Segment or DP	V_F		2.1	2.5	V	$I_F = 10 \text{ mA}$
	Peak Wavelength	λ_{PEAK}		566		nm	
	Dominant Wavelength ^[3]	λ_d		571		nm	
	Reverse Voltage/Segment or DP ^[4]	V_R	3	50		V	$I_R = 100 \mu\text{A}$
	Thermal Resistance LED Junction-to-Pin	$R_{\theta\text{J-PIN}}$		200		$^{\circ}\text{C/W/Seg}$	

Notes:

1. Case temperature of device immediately prior to the intensity measurement is 25°C.
2. The digits are categorized for luminous intensity. The intensity category is designated by a letter on the side of the package.
3. The dominant wavelength, λ is derived from the CIE chromaticity diagram and is that single wavelength which defines the color of the device.
4. Typical specification for reference only. Do not exceed absolute maximum ratings.

AlGaAs Low Current

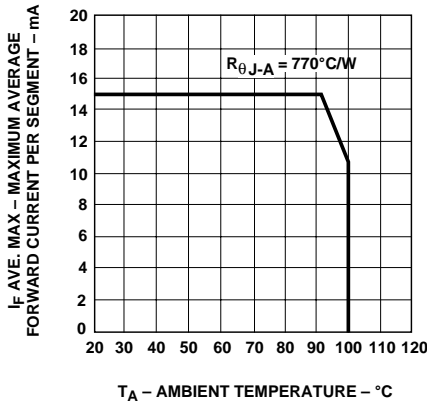

Figure 1. Maximum Allowable Average or DC Current vs. Ambient Temperature.

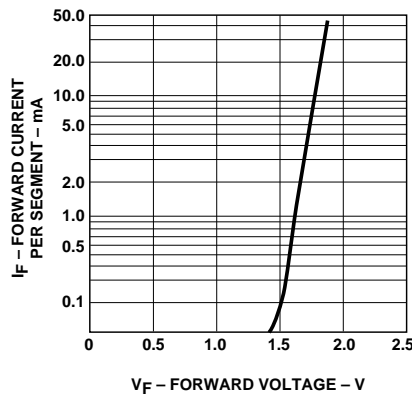

Figure 2. Forward Current vs. Forward Voltage.

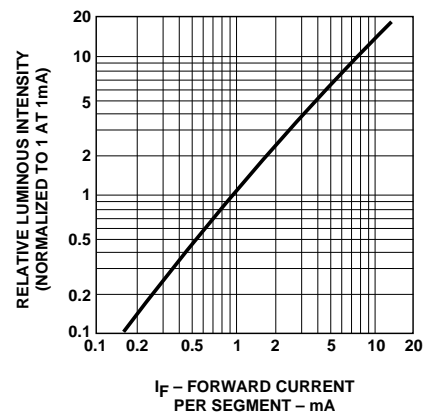

Figure 3. Relative Luminous Intensity vs DC Forward Current.

HER, Yellow, and Green

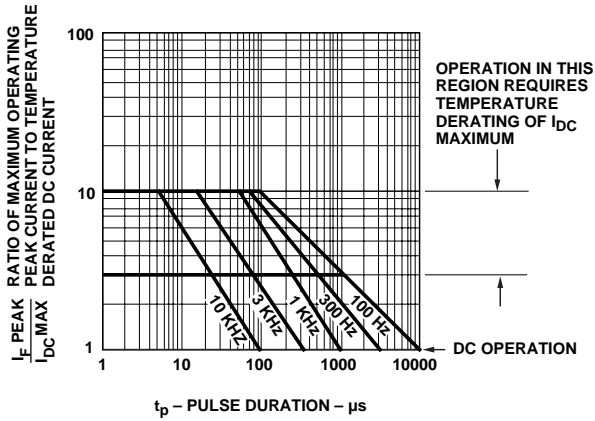

Figure 4. Maximum Tolerable Peak Current vs. Pulse Duration - HER.

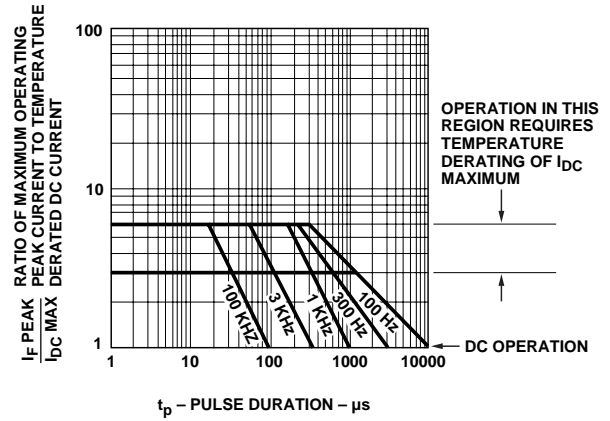

Figure 5. Maximum Tolerable Peak Current vs. Pulse Duration - Yellow.

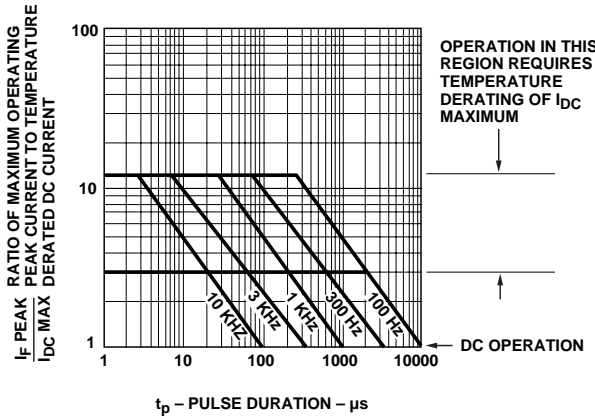

Figure 6. Allowable Peak Current vs. Pulse Duration - Green.

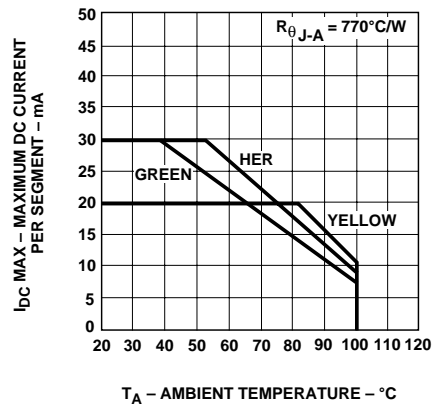

Figure 7. Maximum Allowable DC Current per Segment as a Function of Ambient Temperature.

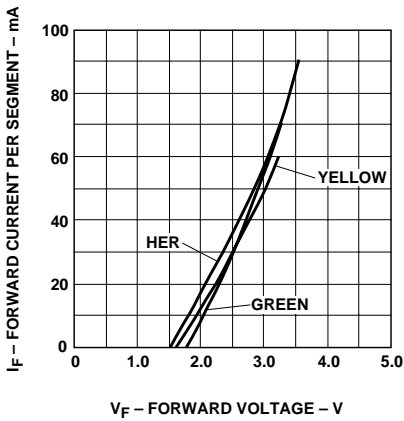

Figure 8. Forward Current vs. Forward Voltage Characteristics.

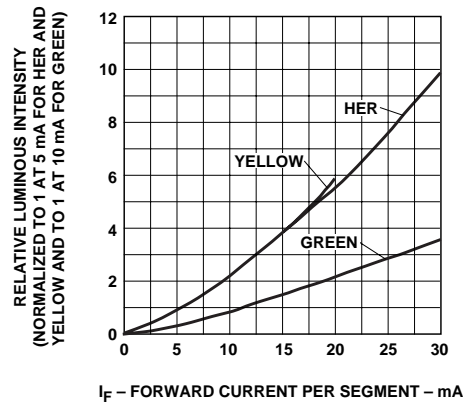

Figure 9. Relative Luminous Intensity vs. DC Forward Current.

HER Low Current

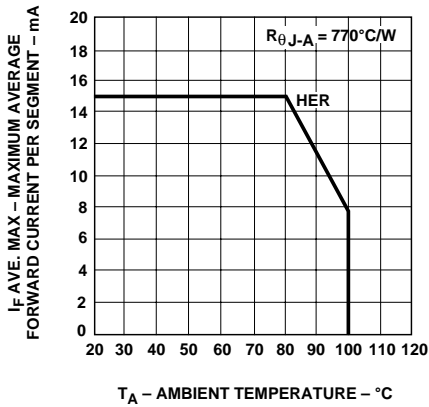

Figure 10. Maximum Allowable Average or DC Current vs. Ambient Temperature.

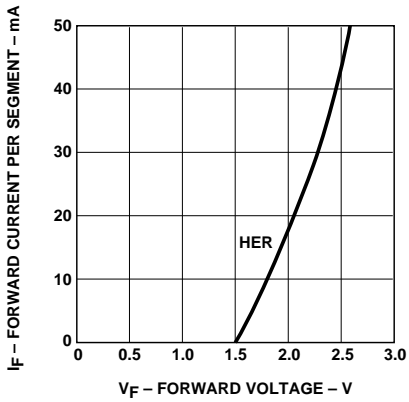

Figure 11. Forward Current vs. Forward Voltage.

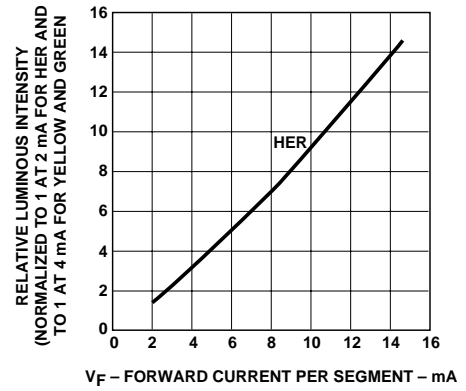

Figure 12. Relative Luminous Intensity vs. DC Forward Current.

Intensity Bin Limits (mcd)

HER Low Current, AlGaAs Red Low Current

HDSP-31xL/H, HDSP-51xL/H		
IV Bin Category	Min.	Max.
E	0.180	0.360
F	0.280	0.560
G	0.450	0.900
H	0.700	1.400
I	1.100	2.200
K	1.800	3.600
L	2.800	5.600
M	4.500	9.000
N	7.000	15.000

HER Std. Current, Green Std. Current, Yellow Std. Current

HDSP-31xE/G/Y, HDSP-51xE/G/Y		
IV Bin Category	Min.	Max.
G	0.450	0.900
H	0.700	1.400
I	1.100	2.200
K	1.800	3.600
L	2.800	5.600
M	4.500	9.000
N	7.000	15.000

Color Categories

Color	Bin	Dominant Wavelength (nm)	
		Min.	Max.
Yellow	1	581.50	585.00
	3	584.00	587.50
	2	586.50	590.00
	4	589.00	592.50
Green	2	573.00	577.00
	3	570.00	574.00
	4	567.00	571.00
	5	564.00	568.00

Note:

All categories are established for classification of products. Products may not be available in all categories. Please contact your local Avago representatives for further clarification/information.

Electrical/Optical

For more information on electrical/optical characteristics, please see Application Note 1005.

Contrast Enhancement

For information on contrast enhancement, please see Application Note 1015.

Soldering/Cleaning

Cleaning agents from the ketone family (acetone, methyl ethyl ketone, etc.) and from the chlorinated hydrocarbon family (methylene chloride, trichloroethylene, carbon tetrachloride, etc.) are not recommended for cleaning LED parts. All of these

various solvents attack or dissolve the encapsulating epoxies used to form the package of plastic LED parts.

For further information on soldering LEDs, please refer to Application Note 1027.

For product information and a complete list of distributors, please go to our website: www.avagotech.com

Avago, Avago Technologies, and the A logo are trademarks of Avago Technologies Limited in the United States and other countries.
Data subject to change. Copyright © 2006 Avago Technologies Limited. All rights reserved. Obsoletes 5988-3204EN
5989-2640EN June 23, 2006

