

Silicon RECTIFIER

A500

3000 Volts 740 Amps Avg.

The A500 Series of high power rectifier diodes feature the newly developed, multi-diffused technology in a new General Electric pressure-mounted package.

FEATURES:

- High Current, *High Voltage*
- Pressure Contacts
- Glazed Ceramic Package with 1" Creepage Path
- Reversibility (eliminates need for special reverse polarity units)
- Hermetic Seal
- Available in Factory Assembled Heat Exchangers or Ready-to-Mount

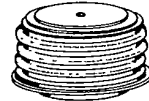

IMPORTANT: Mounting instructions on the last page of the C501 specification must be followed.

MAXIMUM ALLOWABLE RATINGS

TYPE	REPETITIVE PEAK REVERSE VOLTAGE, V_{RRM} $T_J = -40^{\circ}\text{C to } +175^{\circ}\text{C}$	NON-REPETITIVE REVERSE VOLTAGE, V_{RSM} $T_J = 0^{\circ}\text{C to } +175^{\circ}\text{C}$	V_{RRM}/V_{RSM} $T_J = -40^{\circ}\text{C to } +200^{\circ}\text{C}$
A500LP	3000 Volts	3100 Volts	2600 Volts
A500LT	2900	3000	2500
A500LN	2800	2900	2400
A500LS	2700	2800	2300
A500LM	2600	2700	2200
A500LE	2500	2600	2100
A500LD	2400	2500	2000
A500LC	2300	2400	1900
A500LB	2200	2300	1800
A500LA	2100	2200	1700
A500L	2000	2100	1600
A500PT	1900	2000	1500
A500PN	1800	1900	1400
A500PS	1700	1800	1300
A500PM	1600	1700	1200

Average Forward Current	740 Amperes, 1 Φ Average
Peak One-Cycle Surge Current	10,000 Amperes
Minimum I^2t Rating (for times ≥ 1.5 msec)	363,000 Ampere ² Seconds
Minimum I^2t Rating (at 8.3 msec)	415,000 Ampere ² Seconds
Maximum Forward Voltage Drop ($T_C = 150^{\circ}\text{C}$, 1000 Amps. Peak)	1.26 Volts
Peak Reverse Leakage Current ($T_J = 175^{\circ}\text{C}$, $V = \text{Rated } V_{RRM}$)	35mA
Maximum Thermal Resistance, $R_{\theta JS}$ (1 ϕ) (Double-Side Cooling)	0.06 $^{\circ}\text{C/Watt}$
Storage Temperature, T_{STG}	-40 $^{\circ}\text{C to } +200^{\circ}\text{C}$
Operating Temperature, T_J	0 $^{\circ}\text{C to } +175^{\circ}\text{C}$
Mounting Force Required	2200 Lbs. \pm 10% 9.8 KN \pm 10%

NOTES:

¹ Assumes a heatsink thermal resistance of less than 1.1 $^{\circ}\text{C/watt}$.

² Non-recurrent voltage and current ratings, as contrasted to repetitive ratings which apply for occasional or unpredictable overloads. For example, the forward surge current ratings are non-recurrent ratings that are used in fault coordination work.

607 A-----00500-1X

A500

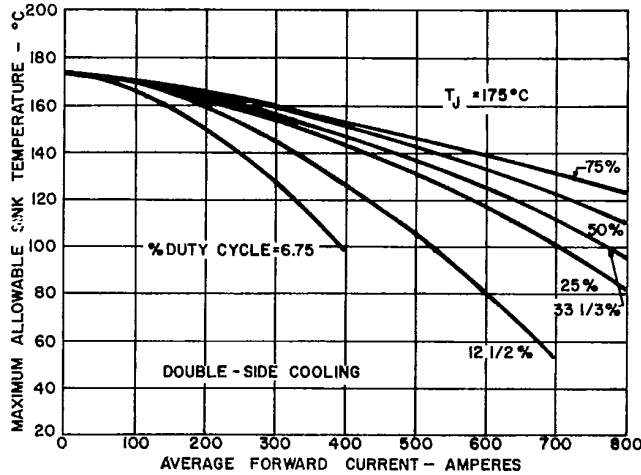

1. AVERAGE FORWARD CURRENT VERSUS MAXIMUM ALLOWABLE SINK TEMPERATURE

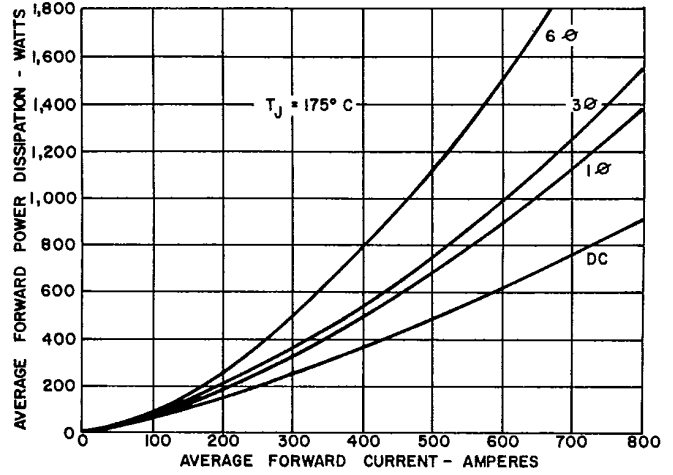

2. AVERAGE FORWARD POWER DISSIPATION VERSUS AVERAGE FORWARD CURRENT

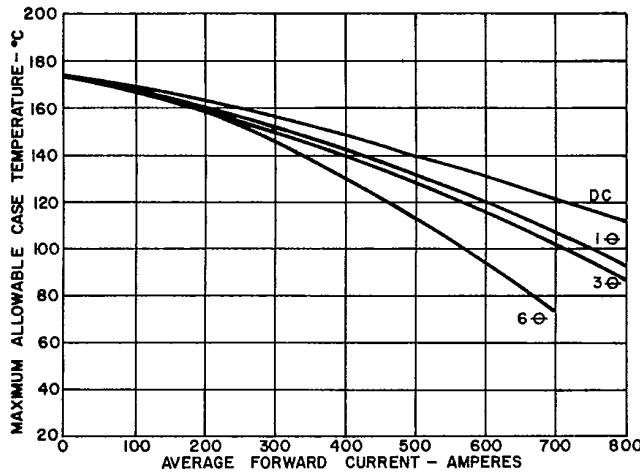

3. MAXIMUM HEAT EXCHANGER TEMPERATURE VERSUS AVERAGE FORWARD CURRENT FOR DOUBLE-SIDE COOLING

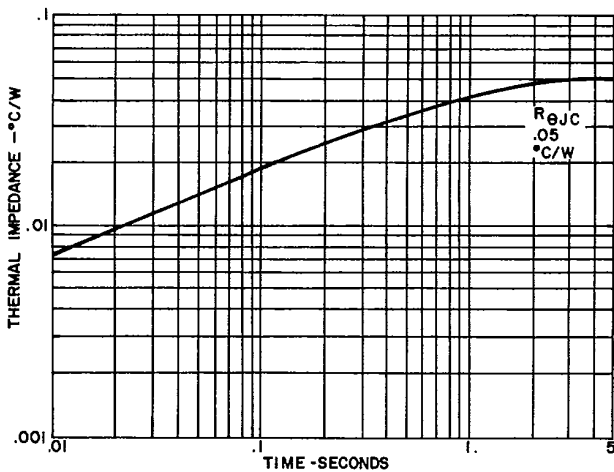

4. TRANSIENT THERMAL IMPEDANCE - JUNCTION-TO-CASE

NOTES:

1. Power "D" adds .01°C/W to account for both case to dissipator interfaces, when properly mounted; e.g., $R_{\theta JS} = .06°C/W$. See Mounting Instructions.
2. DC Thermal Impedance is based on average full cycle junction temperature. Instantaneous junction temperature may be calculated using the following modifications.
 - end of conducting portion of cycle
 - 120° sq. wave add .0065°C/W along entire curve
 - 180° sq. wave add .0047°C/W along entire curve
 - 180° sine wave add .0026°C/W along entire curve
 - end of full cycle
 - any wave, subtract .0026°C/W along entire curve

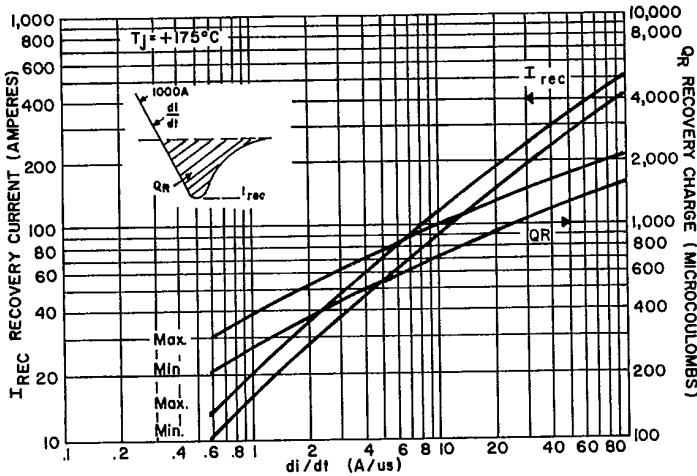

5. REVERSE RECOVERY CHARACTERISTICS

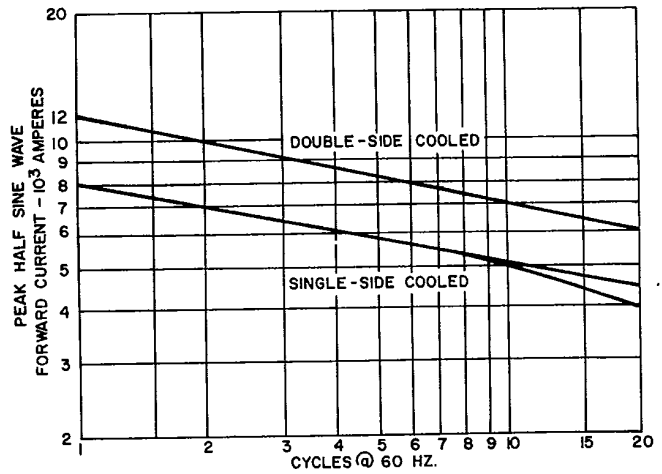

6. MAXIMUM SURGE CURRENT FOLLOWING RATED LOAD CONDITIONS

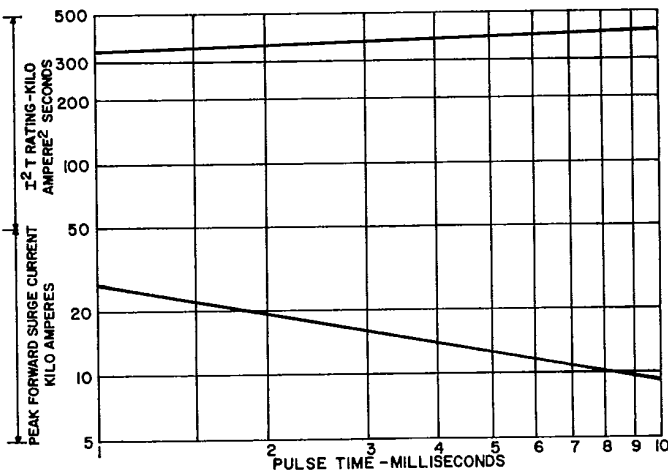

7. SUBCYCLE PEAK SURGE FORWARD CURRENT AND I^2t RATING FOLLOWING RATED LOAD CONDITIONS

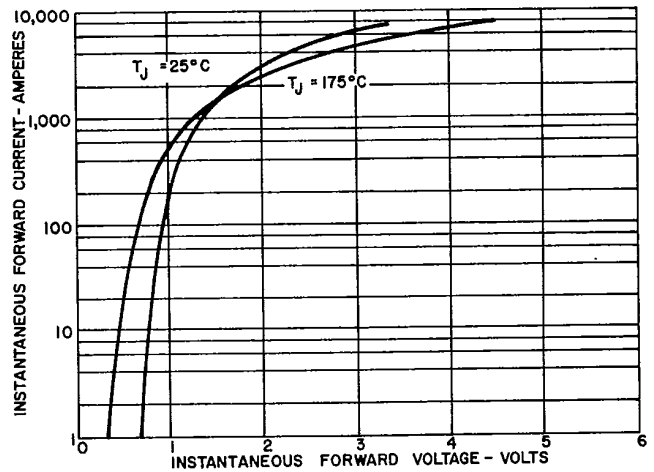

8. MAXIMUM ON-STATE CHARACTERISTICS

OUTLINE DRAWING

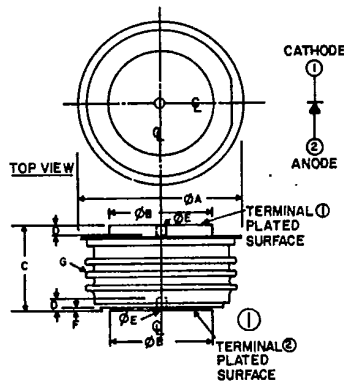

NOTE:
1. GLAZED CERAMIC INSULATOR
WITH 1.00 INCH MIN. SURFACE
CREEPPAGE (25.40mm)

SYMBOL	INCHES		MILLIMETERS		NOTE
	MIN	MAX	MIN	MAX	
ϕA	—	2.000	—	50.80	
ϕB	1.240	1.260	31.50	32.00	
C	1.000	1.060	25.40	26.92	
D	.080	—	2.03	—	
ϕE	0.136	0.146	3.45	3.71	
F	.034	—	0.86	—	
G	—	—	—	—	1

A-----00500-3A