

LS A670, LO A670, LY A670, LG A670, LP A670



Besondere Merkmale

- **Gehäusetyp:** weißes SMT-Gehäuse
- **Besonderheit des Bauteils:** Abstrahlung parallel zur Platine, deshalb ideal zur Einkopplung in Lichtleiter
- **Wellenlänge:** 628 nm (super-rot), 606 nm (orange), 587 nm (gelb), 570 nm (grün), 560 nm (pure green)
- **Abstrahlwinkel:** Lambertischer Strahler (120°)
- **Technologie:** GaAIP (super-rot, orange, gelb, grün), GaP (pure green)
- **optischer Wirkungsgrad:** 1,5 lm/W (super-rot, orange, gelb), 2,5 lm/W (grün), 0,6 lm/W (pure green)
- **Gruppierungsparameter:** Lichtstärke, Wellenlänge
- **Verarbeitungsmethode:** für alle SMT-Bestücktechniken geeignet
- **Lötmethode:** IR Reflow Löten und Wellenlöten (TTW)
- **Vorbehandlung:** nach JEDEC Level 2
- **Gurtung:** 12-mm Gurt mit 2000/Rolle, ø330 mm

Anwendungen

- Hinterleuchtung (LCD, Handy, Schalter, Tasten, Displays, Werbebeleuchtung, Allgemeinbeleuchtung)
- Einkopplung in Lichtleiter
- Signal- und Symbolleuchten
- Innenbeleuchtung im Automobilbereich (z.B. Instrumentenbeleuchtung, u.ä.)
- Markierungsbeleuchtung (z.B. Stufen, Fluchtwege, u.ä.)

Features

- **package:** white SMT package
- **feature of the device:** radiation direction parallel to PCB, so an ideal LED for coupling in light guides
- **wavelength:** 628 nm (super-red), 606 nm (orange), 587 nm (yellow), 570 nm (green), 560 nm (pure green)
- **viewing angle:** Lambertian Emitter (120°)
- **technology:** GaAIP (super-red, orange, yellow, green), GaP (pure green)
- **optical efficiency:** 1.5 lm/W (super-red, orange, yellow), 2.5 lm/W (green), 0.6 lm/W (pure green)
- **grouping parameter:** luminous intensity, wavelength
- **assembly methods:** suitable for all SMT assembly methods
- **soldering methods:** IR reflow soldering and TTW soldering
- **preconditioning:** acc. to JEDEC Level 2
- **taping:** 12-mm tape with 2000/reel, ø330 mm

Applications

- backlighting (LCD, cellular phones, switches, keys, displays, illuminated advertising, general lighting)
- coupling into light guides
- signal and symbol luminaire
- interior automotive lighting (e.g. dashboard backlighting, etc.)
- marker lights (e.g. steps, exit ways, etc.)

LS A670, LO A670, LY A670, LG A670, LP A670

Typ	Emissions- farbe	Farbe der Lichtaustritts- fläche	Lichtstärke	Lichtstrom	Bestellnummer
Type	Color of Emission	Color of the Light Emitting Area	Luminous Intensity $I_F = 10 \text{ mA}$ $I_V \text{ (mcd)}$	Luminous Flux $I_F = 10 \text{ mA}$ $\Phi_V \text{ (mlm)}$	Ordering Code
LS A670-H2J2-1 LS A670-J2L1-1	super-red	colorless clear	3.55 ... 7.10 5.60 ... 14.00	15 (typ.) 28 (typ.)	Q62703-Q5072 Q62703-Q5073
LO A670-J1K1-24 LO A670-K1L2-24	orange	colorless clear	4.50 ... 9.00 5.60 ... 18.00	20 (typ.) 36 (typ.)	Q62703-Q5030 Q62703-Q5031
LY A670-J1K1-26 LY A670-K1L2-26	yellow	colorless clear	4.50 ... 9.00 5.60 ... 18.00	20 (typ.) 36 (typ.)	Q62703-Q5109 Q62703-Q5110
LG A670-K1L1-1 LG A670-L1M2-1	green	colorless clear	7.10 ... 14.00 11.20 ... 28.00	31 (typ.) 56 (typ.)	Q62703-Q4998 Q62703-Q4999
LP A670-G1H1-1 LP A670-H1J2-1	pure green	colorless clear	1.80 ... 3.55 2.80 ... 7.10	7.7 (typ.) 14.0 (typ.)	Q62703-Q5054 Q62703-Q5055

Anm.: -1 gesamter Farbbereich, Lieferung in Einzelgruppen (siehe **Seite 4**)
 -24 gesamter Farbbereich, Lieferung in Einzelgruppen (siehe **Seite 5**)
 -26 gesamter Farbbereich, Lieferung in Einzelgruppen (siehe **Seite 5**)

*Die Standardlieferform von Serientypen beinhaltet eine untere bzw. eine obere Familiengruppe, die aus nur 3 bzw. 4 Halbgruppen besteht. Einzelne Halbgruppen sind nicht erhältlich.
 In einer Verpackungseinheit / Gurt ist immer nur eine Halbgruppe enthalten.*

Note: -1 Total color tolerance range, delivery in single groups (please see **page 4**)
 -24 Total color tolerance range, delivery in single groups (please see **page 5**)
 -26 Total color tolerance range, delivery in single groups (please see **page 5**)

*The standard shipping format for serial types includes a lower or upper family group of 3 or 4 individual groups. Individual half groups are not available.
 No packing unit / tape ever contains more than one luminous intensity half group.*

Grenzwerte
Maximum Ratings

Bezeichnung Parameter	Symbol Symbol	Wert Value		Einheit Unit
		LS, LO, LY, LG	LP	
Betriebstemperatur Operating temperature range	T_{op}	- 40 ... + 100		°C
Lagertemperatur Storage temperature range	T_{stg}	- 40 ... + 100		°C
Sperrschichttemperatur Junction temperature	T_j	+ 100		°C
Durchlassstrom Forward current	I_F	30		mA
Stoßstrom Surge current $t \leq 10 \mu s, D = 0.005$	I_{FM}	0.5		A
Sperrspannung Reverse voltage	V_R	5		V
Leistungsaufnahme Power consumption	P_{tot}	95	90	mW
Wärmewiderstand Thermal resistance Sperrschicht/Umgebung Junction/air	$R_{th JA}$	430		K/W
Sperrschicht/Lötpad Junction/soldering point Montage auf PC-Board FR 4 (Padgröße $\geq 16 \text{ mm}^2$) mounted on PC board FR 4 (pad size $\geq 16 \text{ mm}^2$)	$R_{th JS}$	200		K/W

Kennwerte ($T_A = 25\text{ °C}$)

Characteristics

Bezeichnung Parameter	Symbol Symbol	Wert Value					Einheit Unit
		LS	LO	LY	LG	LP	
Wellenlänge des emittierten Lichtes (typ.) Wavelength at peak emission $I_F = 10\text{ mA}$	λ_{peak}	635	610	586	572	557	nm
Dominantwellenlänge ¹⁾ (typ.) Dominant wavelength $I_F = 10\text{ mA}$	λ_{dom}	628 ± 6	606 $+3/-6$	587 $+8/-7$	570 ± 6	560 ± 6	nm
Spektrale Bandbreite bei 50 % $I_{\text{rel max}}$ (typ.) Spectral bandwidth at 50 % $I_{\text{rel max}}$ $I_F = 10\text{ mA}$	$\Delta\lambda$	45	40	45	25	22	nm
Abstrahlwinkel bei 50 % I_V (Vollwinkel) (typ.) Viewing angle at 50 % I_V	2ϕ	120	120	120	120	120	Grad deg.
Durchlassspannung ²⁾ (typ.) Forward voltage $I_F = 10\text{ mA}$	V_F V_F	2.0 2.5	2.0 2.5	2.0 2.5	2.0 2.5	2.0 2.5	V V
Sperrstrom (typ.) Reverse current $V_R = 5\text{ V}$	I_R I_R	0.01 10	0.01 10	0.01 10	0.01 10	0.01 10	μA μA
Temperaturkoeffizient von λ_{peak} (typ.) Temperature coefficient of λ_{peak} $I_F = 10\text{ mA}; -10\text{ °C} \leq T \leq 100\text{ °C}$	$TC_{\lambda_{\text{peak}}}$	0.11	0.12	0.10	0.11	0.11	nm/K
Temperaturkoeffizient von λ_{dom} (typ.) Temperature coefficient of λ_{dom} $I_F = 10\text{ mA}; -10\text{ °C} \leq T \leq 100\text{ °C}$	$TC_{\lambda_{\text{dom}}}$	0.07	0.07	0.07	0.07	0.05	nm/K
Temperaturkoeffizient von V_F (typ.) Temperature coefficient of V_F $I_F = 10\text{ mA}; -10\text{ °C} \leq T \leq 100\text{ °C}$	TC_V	-1.9	-1.9	-1.9	-1.4	-2.1	mV/K
Optischer Wirkungsgrad (typ.) Optical efficiency $I_F = 10\text{ mA}$	η_{opt}	1.5	1.5	1.5	2.5	0.6	lm/W

¹⁾ Wellenlängen werden mit einer Stromeinprägedauer von 25 ms und einer Genauigkeit von $\pm 1\text{ nm}$ ermittelt.
Wavelengths are tested at a current pulse duration of 25 ms and a tolerance of $\pm 1\text{ nm}$.

²⁾ Spannungswerte werden mit einer Stromeinprägedauer von 1 ms und einer Genauigkeit von $\pm 0,1\text{ V}$ ermittelt.
Voltages are tested at a current pulse duration of 1 ms and a tolerance of $\pm 0.1\text{ V}$.

1) Wellenlängengruppen / Wavelength groups

Gruppe Group	yellow		orange		Einheit Unit
	min.	max.	min.	max.	
2	580	583	600	603	nm
3	583	586	603	606	nm
4	586	589	606	609	nm
5	589	592			nm
6	592	595			nm

Helligkeits-Gruppierungsschema
Luminous Intensity Groups

Lichtgruppe Luminous Intensity Group	Lichtstärke Luminous Intensity I_V (mcd)	Lichtstrom Luminous Flux Φ_V (mlm)
G1	1.80 ... 2.24	6.0 (typ.)
G2	2.24 ... 2.80	7.5 (typ.)
H1	2.80 ... 3.55	9.5 (typ.)
H2	3.55 ... 4.50	12.0 (typ.)
J1	4.50 ... 5.60	15.0 (typ.)
J2	5.60 ... 7.10	19.0 (typ.)
K1	7.10 ... 9.00	24.0 (typ.)
K2	9.00 ... 11.20	30.0 (typ.)
L1	11.20 ... 14.00	40.0 (typ.)
L2	14.00 ... 18.00	50.0 (typ.)
M1	18.00 ... 22.40	60.0 (typ.)
M2	22.40 ... 28.00	75.0 (typ.)

Helligkeitswerte werden mit einer Stromeinprägedauer von 25 ms und einer Genauigkeit von $\pm 11\%$ ermittelt.
Luminous intensity is tested at a current pulse duration of 25 ms and a tolerance of $\pm 11\%$.

Gruppenbezeichnung auf Etikett
Group Name on Label

Beispiel: K1-3
Example: K1-3

Lichtgruppe Luminous Intensity Group	Halbgruppe Half Group	Wellenlänge Wavelength
K	1	3

Relative spektrale Emission $I_{rel} = f(\lambda)$, $T_A = 25\text{ °C}$, $I_F = 10\text{ mA}$

Relative Spectral Emission

$V(\lambda)$ = spektrale Augenempfindlichkeit

Standard eye response curve

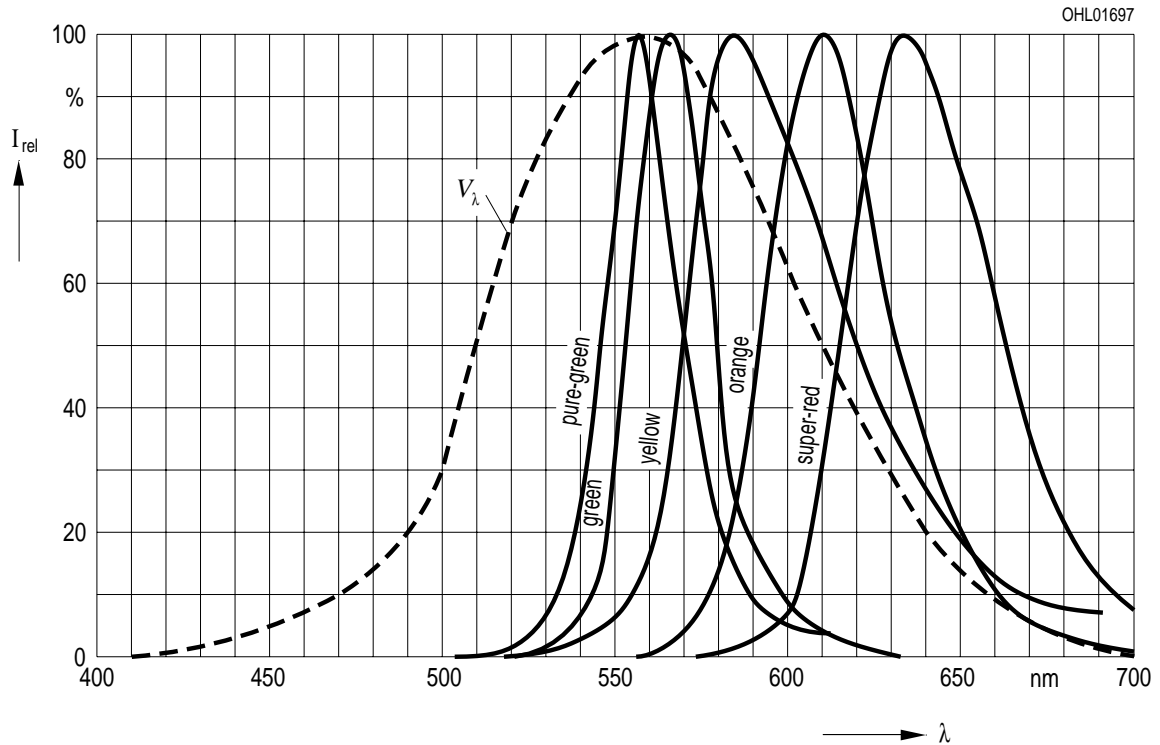

Abstrahlcharakteristik $I_{rel} = f(\varphi)$

Radiation Characteristic

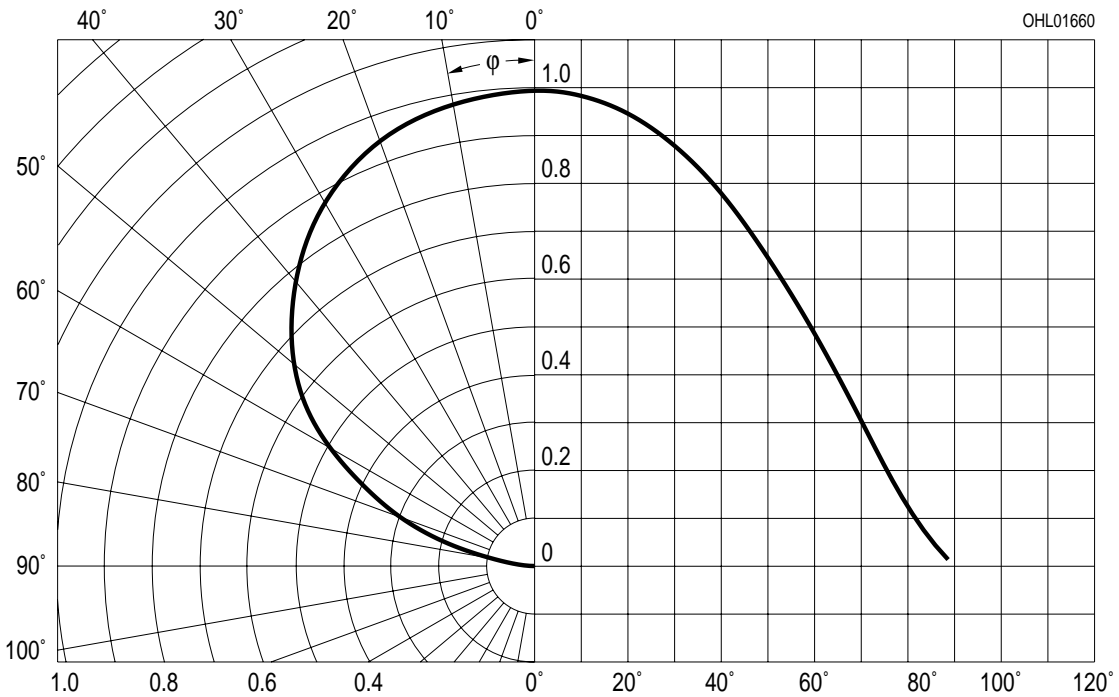

Durchlassstrom $I_F = f(V_F)$
Forward Current

$T_A = 25\text{ °C}$

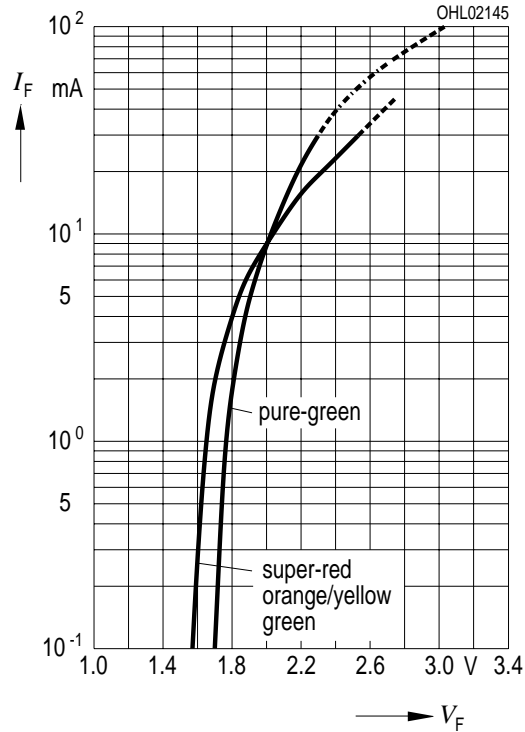

Relative Lichtstärke $I_V/I_{V(10\text{ mA})} = f(I_F)$
Relative Luminous Intensity

$T_A = 25\text{ °C}$

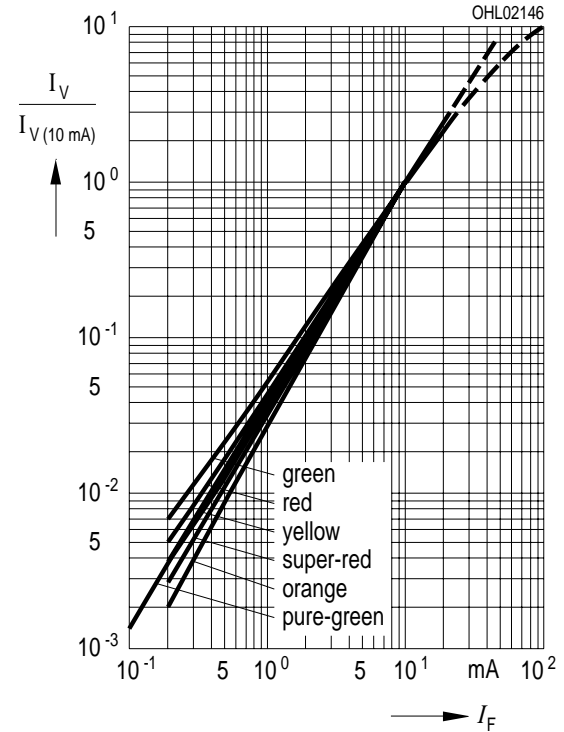

Maximal zulässiger Durchlassstrom $I_F = f(T)$
Max. Permissible Forward Current

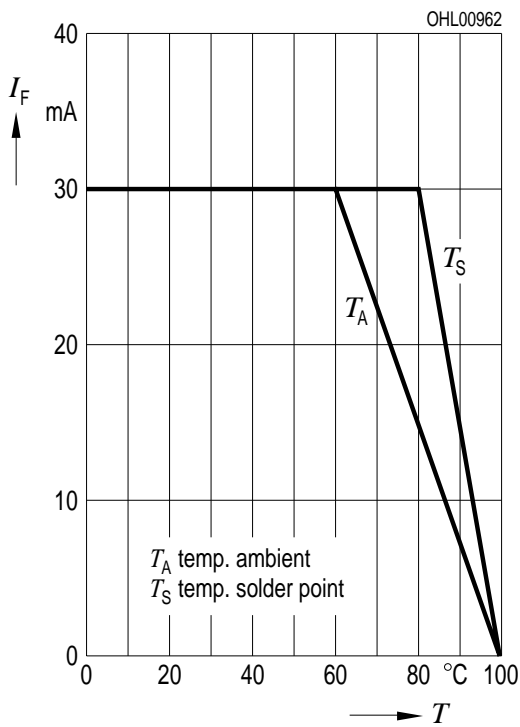

Relative Lichtstärke $I_V / I_{V(25\text{ °C})} = f(T_A)$
Relative Luminous Intensity

$I_F = 10\text{ mA}$

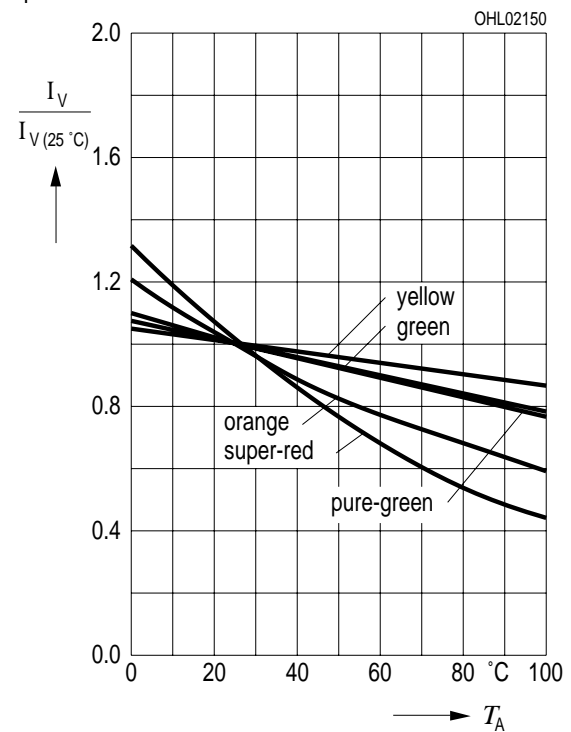

Zulässige Impulsbelastbarkeit $I_F = f(t_p)$
Permissible Pulse Handling Capability

Duty cycle $D =$ parameter, $T_A = 25\text{ °C}$

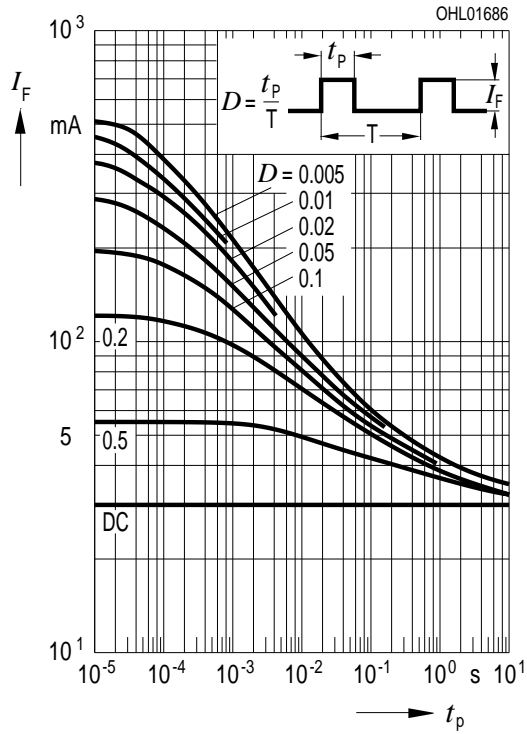

Maßzeichnung
Package Outlines

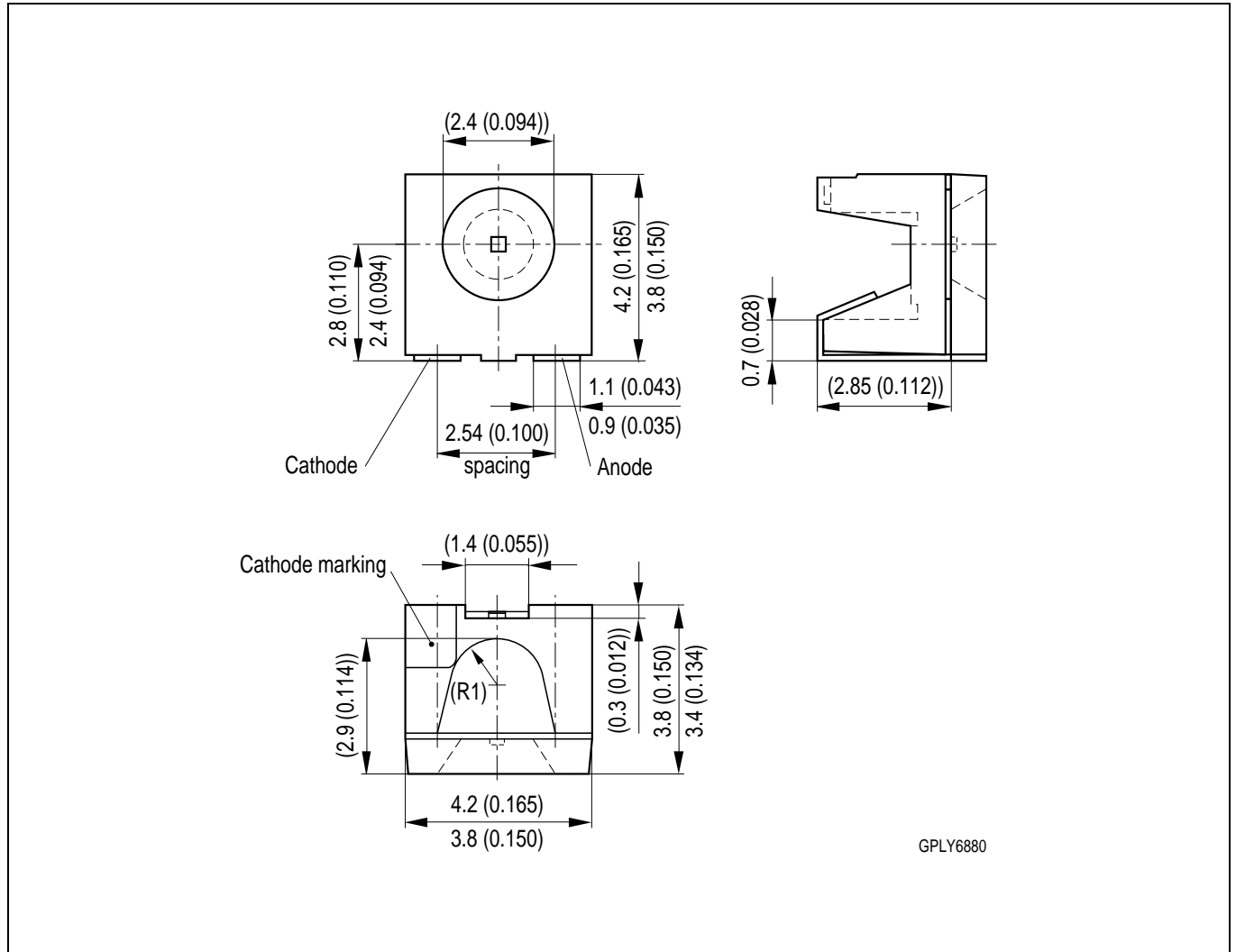

Maße werden wie folgt angegeben: mm (inch) / Dimensions are specified as follows: mm (inch).

Kathodenkennung: abgeschrägte Ecke
Cathode mark: bevelled edge
Gewicht / Approx. weight: 40 mg

Lötbedingungen Vorbehandlung nach JEDEC Level 2
Soldering Conditions Preconditioning acc. to JEDEC Level 2

IR-Reflow Lötprofil (nach IPC 9501)
IR Reflow Soldering Profile (acc. to IPC 9501)

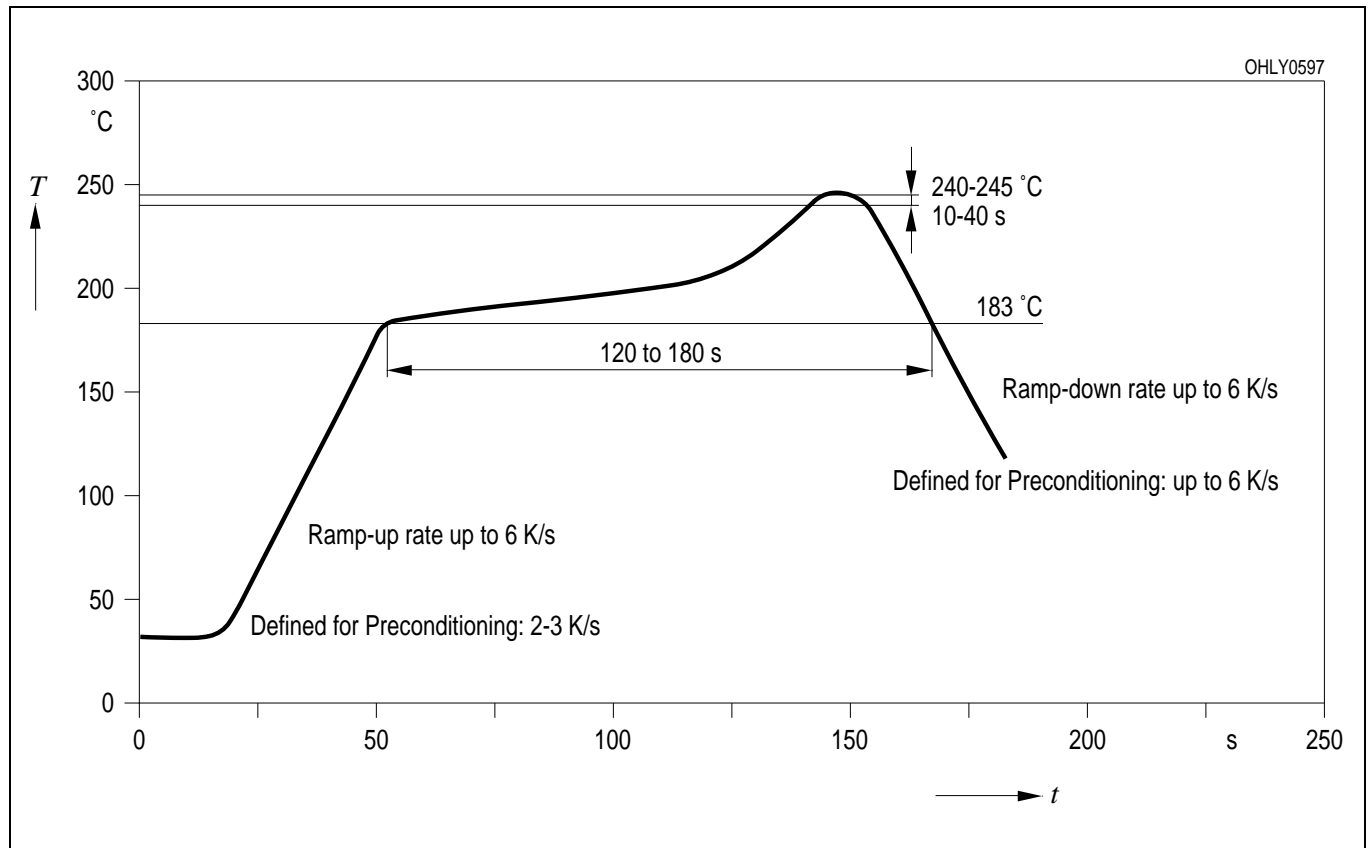

Wellenlötten (TTW) (nach CECC 00802)
TTW Soldering (acc. to CECC 00802)

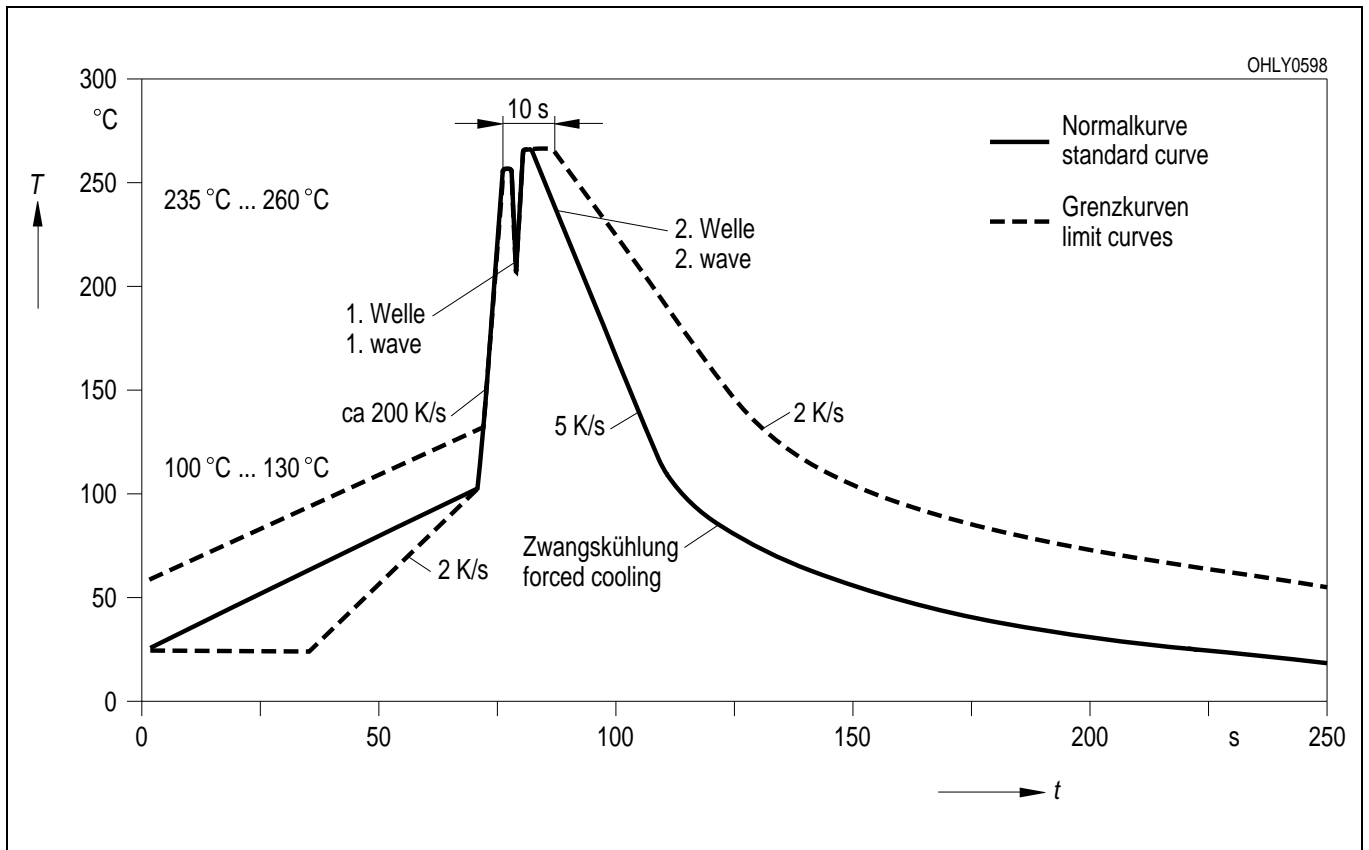

Empfohlenes Lötpad Design IR Reflow Löten / Wellenlöten / TTW
Recommended Solder Pad IR Reflow Soldering / TTW Soldering

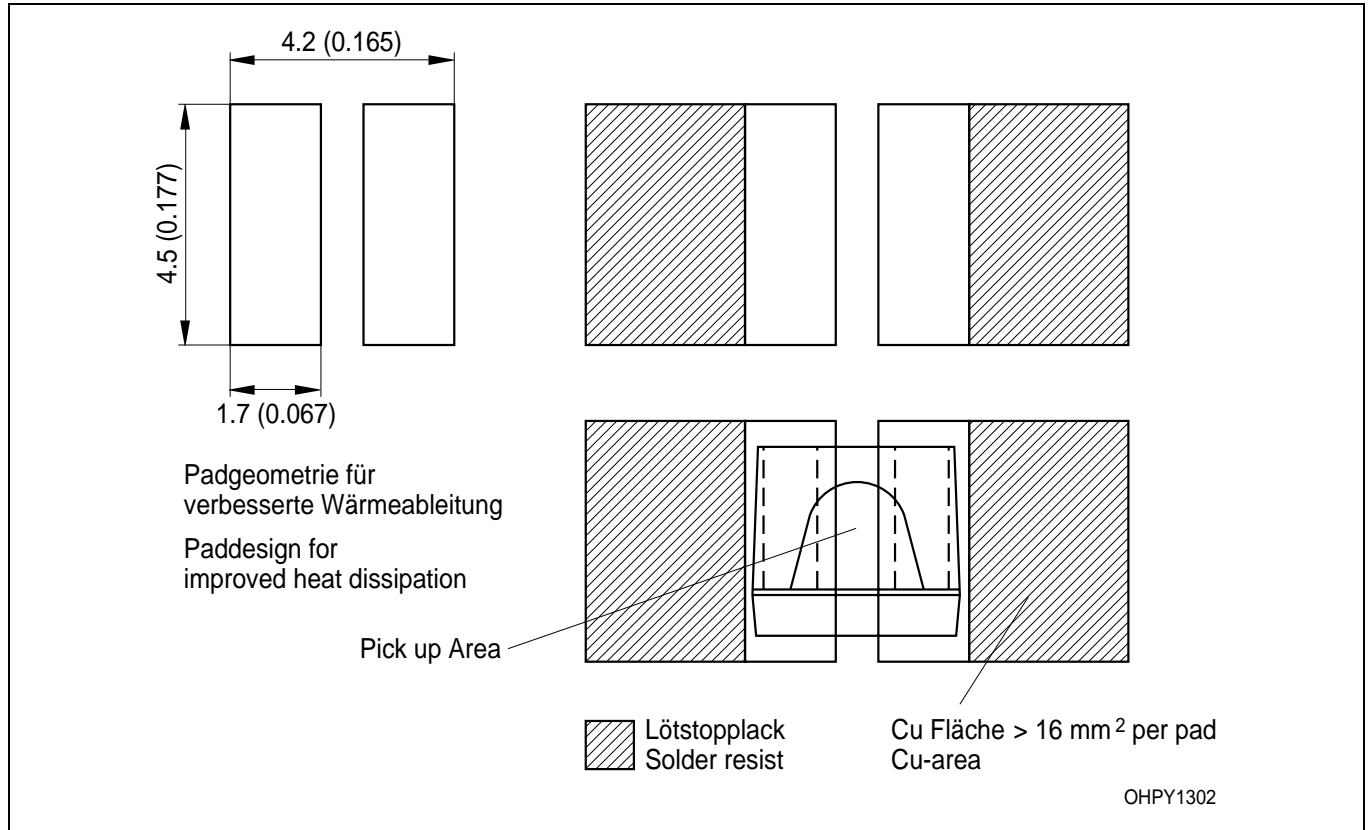

Maße werden wie folgt angegeben: mm (inch) / Dimensions are specified as follows: mm (inch).

Gurtung / Polarität und Lage Verpackungseinheit 2000/Rolle, ø330 mm
Method of Taping / Polarity and Orientation Packing unit 2000/reel, ø330 mm

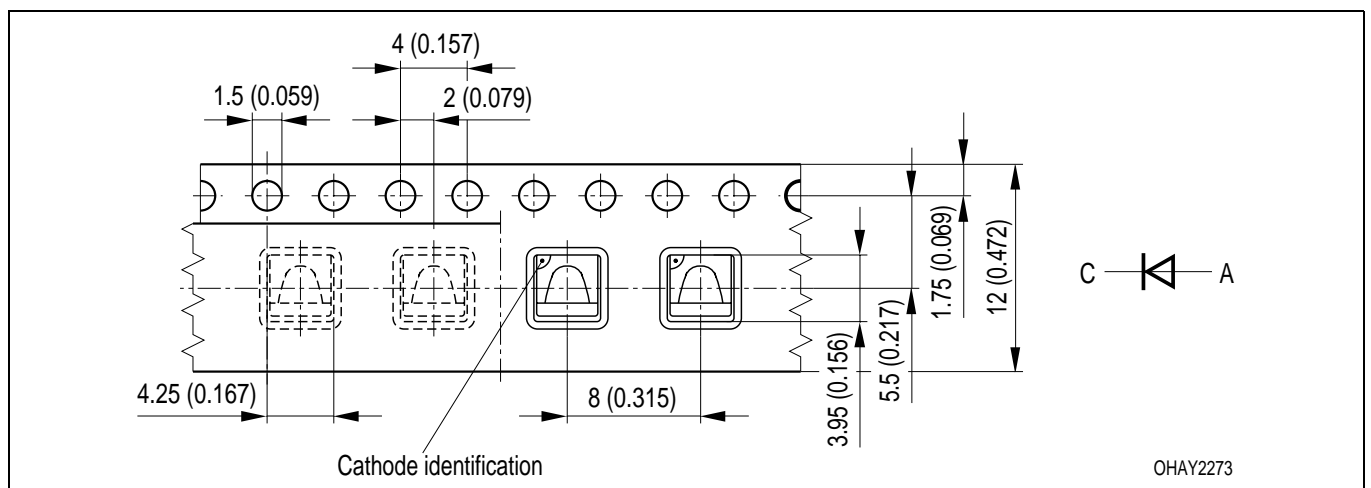

Maße werden wie folgt angegeben: mm (inch) / Dimensions are specified as follows: mm (inch).

Revision History: 2002-04-03

Previous Version: 2001-05-07

Page	Subjects (major changes since last revision)
12	recommended solder pad
12	recommended solder pad extended to TTW soldering
2	wavelength grouping for yellow and green

Published by OSRAM Opto Semiconductors GmbH & Co. OHG
Wernerwerkstrasse 2, D-93049 Regensburg

© All Rights Reserved.

Attention please!

The information describes the type of component and shall not be considered as assured characteristics. Terms of delivery and rights to change design reserved. Due to technical requirements components may contain dangerous substances. For information on the types in question please contact our Sales Organization. If printed or downloaded, please find the latest version in the Internet.

Packing

Please use the recycling operators known to you. We can also help you – get in touch with your nearest sales office. By agreement we will take packing material back, if it is sorted. You must bear the costs of transport. For packing material that is returned to us unsorted or which we are not obliged to accept, we shall have to invoice you for any costs incurred.

Components used in life-support devices or systems must be expressly authorized for such purpose! Critical components ¹ may only be used in life-support devices or systems ² with the express written approval of OSRAM OS.

¹ A critical component is a component used in a life-support device or system whose failure can reasonably be expected to cause the failure of that life-support device or system, or to affect its safety or the effectiveness of that device or system.

² Life support devices or systems are intended (a) to be implanted in the human body, or (b) to support and/or maintain and sustain human life. If they fail, it is reasonable to assume that the health of the user may be endangered.