

Large Current Driver
BA614A

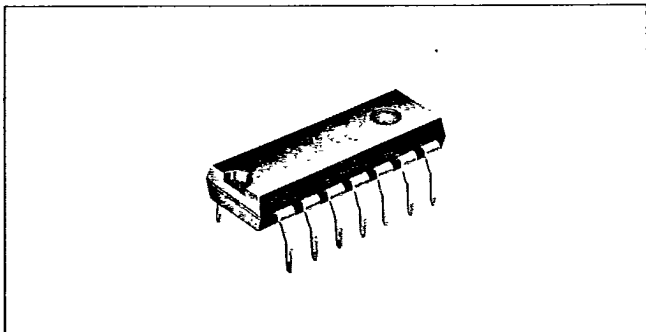

Dimensions (Unit: mm)

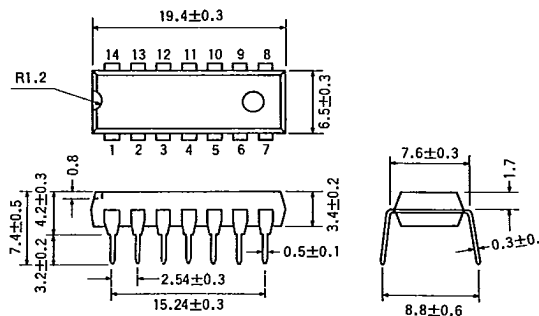

Fig. 1

The BA614A is a six Darlington transistor array with input resistors. The inputs and outputs are arranged on adjacent pins to allow easy board layout.

Features

1. Contains six Darlington transistor arrays.
2. Large current driving capability (100 mA max.).
3. Inputs/outputs arranged on adjacent pins to allow easy board layout.
4. Directly compatible with MOS devices.
5. Large current amplification ratio.
6. High input and output voltages: 38 V and 24 V.

Applications

- Solenoid hammer drivers
- Relay drivers
- LED drivers

Block Diagram

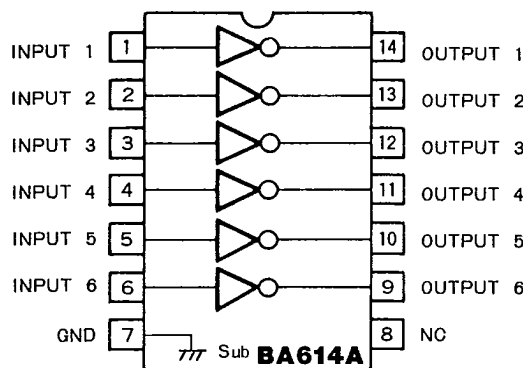

Fig. 2

Circuit Diagram

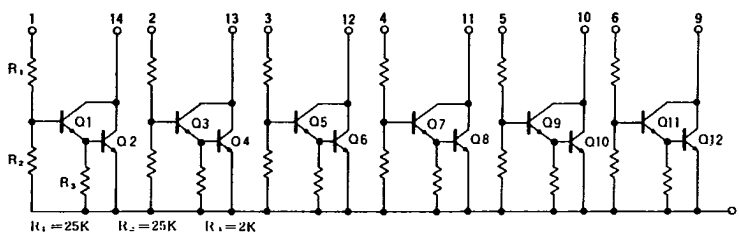

Fig. 3

Absolute Maximum Ratings (Ta=25°C)

Parameter	Symbol	Limits	Unit
Supply voltage	V _{CC}	24	V
Collector voltage	V _C	100	mV
Input voltage (+)	V ₊	38	V
Input voltage (-)	V ₋	-0.5	V
Power dissipation	P _d	550*	mW
Operating temperature range	T _{opr}	-25 ~ 75	°C
Storage temperature range	T _{stg}	-55 ~ 125	°C

*Derating is done at 5.5 mW/°C for operation above Ta=25°C.

Electrical Characteristics (Ta=25°C)

Parameter	Symbol	Min.	Typ.	Max.	Unit	Conditions	Test circuit
Supply voltage range (output)	V _{CC}	—	—	20	V	—	—
Output leakage current	I _L	—	—	100	μA	V _C =20V, V _{IN} =0V	Fig. 8
Collector saturation voltage	V _{CE(sat)}	—	1.4	2.2	V	I _{OUT} =75mA, V _{IN} =17V	Fig. 9
Input current	I _{IN}	—	1.6	3.2	mA	V _{IN} =35V, I _{OUT} =0mA	Fig. 10

Electrical Characteristic Curves

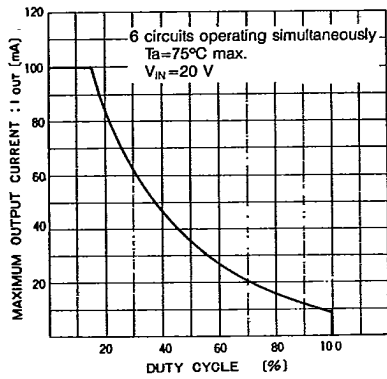

Fig. 4 Maximum output current vs. duty cycle

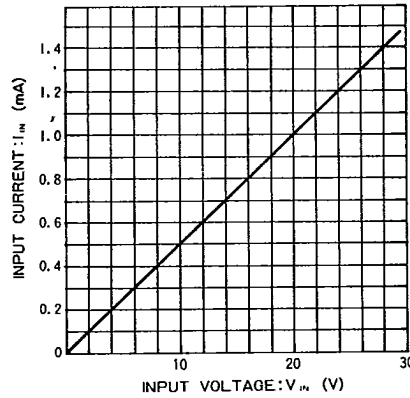

Fig. 5 Input current vs. input voltage

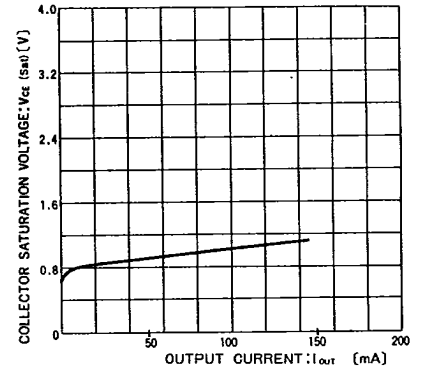

Fig. 6 Collector saturation voltage vs. output current

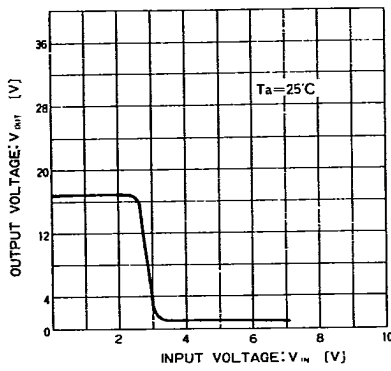

Fig. 7 Output voltage vs. input voltage

Test Circuits

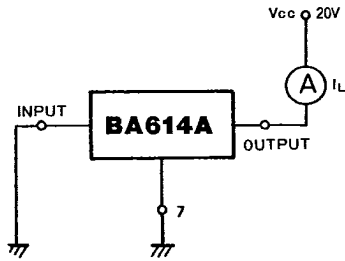

Fig. 8 Output leakage current test circuit

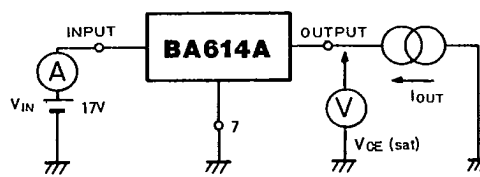

Fig. 9 Collector saturation voltage test circuit

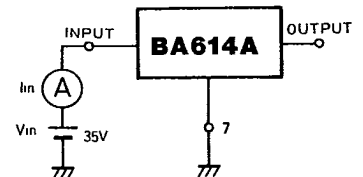

Fig. 10 Input current test circuit

Application Example

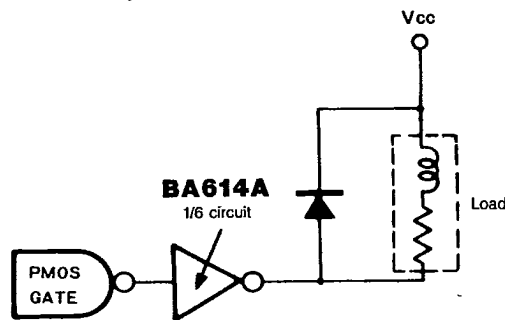

Fig. 11

For inductive load driving, use the connection as shown in Fig. 11. To suppress surge current from the inductive load, use a clamping diode in parallel with the load.